

TimeSource 2500

GPS Primary Reference Source with Rooftop Antenna



Symmetricom, Inc.

2300 Orchard Parkway
San Jose, CA 95131-1017

<http://www.symmetricom.com>

Copyright © 1999–2000 Symmetricom, Inc.

All rights reserved. Printed in U.S.A.

All product names, service marks, trademarks and registered trademarks used in this document are the property of their respective owners.

Description

Chapter I

Introduction	14
Global Positioning System	15
Physical Description	16
Functional Description	18
Overview	18
Antenna	20
GPS Receiver	20
Local Oscillator	20
Clock Extractors	21
Power Supply	21
BesTime Ensemble Timing Generator	21
TI Output	21
10 MHz Output	22
TOD Output	22
BTMONitor Software	22
Alarm Interface	22

Engineering & Ordering Chapter 2

Site Survey	24
Lightning Suppressor Guidelines	25
Antenna Location Guidelines	26
Cabling Considerations	32
Cabling for Standard Antennas	33
100 Foot Maximum Antenna- to-Shelf Cabling	33
100–200 Foot Antenna-to-Shelf Cabling	36
Cabling for High-Gain Antennas	38
Shelf Considerations	45
Rack Mounted	45
Wall Mounted	45
Computer Requirements	46
Ordering Information	47
Shelves.....	47
Rack-Mounted.....	47
Wall-Mounted.....	49
Antenna Kits	51
Standard Antenna.....	51
40 dB High-Gain Antenna.....	51
50 dB High-Gain Antenna.....	52
Antenna Cable Kits	53
Standard Antenna Cable Kits	53
40 dB Antenna Cable Kits	56
50 dB Antenna Cable Kits.....	58
Optional Cable Tools	61

Engineering &
Ordering
Chapter 2
(cont'd)

User-Supplied Tools and Materials 62
 For Antenna Installation 62
 For Shelf Installation 63

Installation
Chapter 3

Unpacking 66
Antenna 67
Shelf 89
 Rack Mounting 89
 Wall Mounting 92
 Cabling 93
 Frame Ground 95
 Power 99
 TI Outputs 101
 Local Communication Port 103
 Alarm Outputs 104
 Remote Communication Port 105
 TI and 5 MHz Inputs 106
 Time of Day Output 108
 10 MHz Output 109
 GPS Antenna 109
Power-Up 110
Remote Operation Via a Modem
 (Optional) 120
Remote Operation via a Terminal Server
 (Optional) 125

Operation

Chapter 4

Introduction	132
View Alarms and Alarm Thresholds ...	133
Change Alarm Thresholds	135
View Span Framing and Trouble Code Sent During Major Alarm	137
View BT3 (TimeSource 2500) Mode and Duration	138
View Alarm Log	139
Clear Alarm Log	140
Change Location ID	141
Change Elevation Mask	142
Enable or Disable Inputs	143
Ensemble Inputs or Exclude Inputs from Ensemble	144
View Input Weighting and Gear	145
View Input Performance Statistics	146
Set Span Framing and Trouble Code Sent During Major Alarm	148

Operation
Chapter 4
(cont'd)

Set TOD Output Format	150
View GPS Tracking Statistics	151
View GPS Satellite Information	152
View Daily Holdover Information	154
View Monthly Holdover Information ...	156
Reset GPS Receiver and System	158
Download New Software	159
View User Accounts	161
Add User Account	162
Delete User Account	165
Edit User Account	166
Change Password	168
View BTMONitor Software Version	169
View Communication Information	170
View System Firmware Information	171

Troubleshooting

Chapter 5

Front Panel Lamps	174
Theory of Alarm Processing and Troubleshooting	176
GPS Event and Alarm Summary	182
GPS Frequency Transient Event ..	183
GPS Frequency Event	183
GPS Frequency Alarm	184
GPS Drift Transient Event	184
GPS Drift Event	184
GPS Drift Alarm	185
GPS Time Accuracy Transient Event	185
GPS Clock Bias Transient Event ..	185
GPS Tracking Success Alarm	186
Antenna Alarm	186
Span Input Event and Alarm	
Summary	187
Span Frequency Transient Event .	187
Span Frequency Alarm	188
Span Drift Transient Event	188
Span Drift Alarm	189
Span Phase Transient Event	189
Span Phase Alarm	190
Span Jitter Alarm	190
Remote Oscillator (RO) Input	
Event and Alarm Summary	191
RO Frequency Transient Event ..	191
RO Frequency Alarm	192
RO Drift Transient Event	192
RO Drift Alarm	193
RO Phase Transient Event	193
RO Phase Alarm	194
RO Jitter Alarm	194

Troubleshooting
Chapter 5
(cont'd)

Phase Locked Loop (PLL) Event and Alarm Summary	195
PLL Step Event	195
PLL Step Alarm	196
PLL Range Event	196
PLL Range Alarm	197
PLL Jitter Alarm	197
Temperature (TP) Event and Alarm Summary	198
TP Step Event	198
TP Step Alarm	198
TP Slew Event	199
TP Slew Alarm	199
TLI Messages	200
Formats	200
Alarms	200
Events	200
Parameters	201
Message Troubleshooting	203
Repair and Return	207
Technical Assistance	209
Sales	210
Manual Updates	211

Specifications

Chapter 6

Standard Antenna	214
40 dB High-Gain Antenna.	215
50 dB High-Gain Antenna.	216
Remote Communication Port	217
Craft Communication Port	217
TI Inputs	218
Remote Oscillator Inputs	219
TI Outputs	220
Time of Day Output	221
10 MHz Output	222
Alarms	223
Indicators	223
Power	224
Shelf Mechanical	224
Wire-Wrap Panel Mechanical	225
Shelf and Wire-Wrap Panel Environmental	225

Acronyms and Abbreviations

1 pps	one pulse per second
AIS	alarm indication signal
BITS	building integrated timing supply
BTMONitor	BesTime Monitoring
DS1	digital signal, level 1 (1.544 Mb/s)
ESD	electrostatic discharge
ESF	extended superframe
GPS	Global Positioning System
LOS	loss of signal
MDEV	mean time deviation
MPU	microprocessor
NTP	Network Time Protocol
ppb	parts per billion
ppm	parts per million
PRS	primary reference source
RO	remote oscillator
RU	rack unit (1.75 inches)
SSM	synchronization status messaging
TI	digital transmission (1.544 Mb/s)
TDEV	time deviation
TLI	Transaction Language 1
TOD	time of day
UTC	Universal Coordinated Time

FCC Regulatory Statement

Warning: This equipment generates, uses, and can radiate radio frequency energy, and if not used in accordance with the instruction manual, may cause interference to radio communications. It has been tested and found to comply with the limits for a Class A computing device pursuant to Subpart B of Part 15 of FCC rules, which are designed to provide reasonable protection against such interference when operated in a commercial environment. Operation of this equipment in a residential area is likely to cause interference in which case the user at his own expense will be required to take whatever measures may be required to correct the interference.

Description

This chapter provides an overview of the global positioning system, and a physical and functional description of the TimeSource 2500.

Introduction

The TimeSource 2500 is a Primary Reference Source (PRS) that receives and processes signals from GPS satellites, and outputs Stratum 1 synchronization signals traceable to UTC. The TimeSource 2500 is ideal for installation in environments where receiving GPS signals is difficult. Examples of environments hostile to GPS signals include urban canyons which have a very limited view of the sky because of blockage from nearby buildings, and high interference zones where GPS signals are jammed by competing over-the-air signals.

The TimeSource 2500 works in environments hostile to GPS by combining advancements in single satellite GPS receiver technology, rubidium local oscillator and predictive holdover technology, and miniaturization of GPS antennas. Synchronization outputs are delivered in multi-format T1 signals, in a 10 MHz signal, and a Time of Day (TOD) signal.

The synchronization timing is traceable to the GPS, which provides the highest level of synchronization for telephony networks. The TimeSource 2500, with its GPS input, is a stand-alone PRS which meets network PRS performance specifications. The system is an ideal alternative to cesium systems for providing Stratum 1 timing to an office BITS system, or as a timing system for network edge and customer premises equipment.

Global Positioning System

The United States Government developed the GPS navigation system. It is a satellite-based radio navigation aid that provides global, all-weather, precise navigation and timing capability to users 24 hours a day.

GPS antennas must have line-of-sight access to the transmitting satellites. Any structure that interferes with, or blocks, the view of the satellites disrupts the reception of the signals, and may adversely impact the timing performance of a receiver.

The TimeSource 2500 optimizes timing performance during frequent GPS outages by anticipating the outages, and compensating for them with advanced local oscillator and holdover technology. BesTime-generated predictor values are used to bridge GPS outage periods and enhance holdover performance.

Physical Description

The TimeSource 2500 consists of a shelf, an antenna, cables, mounting hardware, and software.

The shelf can be mounted on a wall or in an industry-standard 19 inch or 23 inch rack. In a rack, the shelf occupies two rack units (RU). All connectors and indicators other than the GPS antenna are at the front of the shelf. An optional wire-wrap panel for rear-access input and output occupies an additional two RU.

Three types of antennas are available: the standard antenna (Figure 1), and the 40 dB and 50 dB high-gain antennas (Figure 2).

Figure 1. Standard Antenna

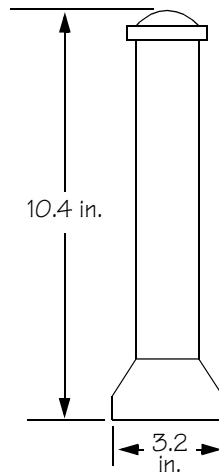
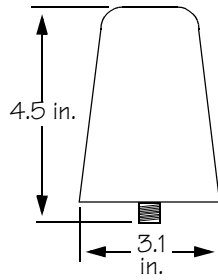

Figure 2. High-Gain Antennas



The antenna should be installed with an unobstructed view of the sky, usually on a roof. A single coaxial cable carries signals and power between the antenna and the shelf.

Functional Description

Overview

Figure 3 shows the main functions of the TimeSource 2500. The center of the TimeSource 2500 is the BesTime Ensemble Timing Generator. The BesTime Ensemble Timing Generator can receive multiple timing references, analyze their phase and frequency characteristics, and dynamically weight each input, to maximize the stability and accuracy of the timing outputs.

In the TimeSource 2500 application, the GPS input normally receives full weight, and actively disciplines the timing outputs. Because of the exceptional stability of the local rubidium oscillator, the optional span line and 5 MHz remote oscillator inputs are not normally used in the ensemble timing output solution. If any of the optional inputs are provisioned for ensembling, the BesTime algorithm continuously determines the optimum input weighting mix, and may use one or all of these references, by dynamically placing increasingly greater weighting values on the most stable input or inputs. Greater weighting values are not normally placed on the optional inputs, but if this is the case, it would occur during extended GPS outage periods.

Even if the optional inputs are not actively used in the output ensemble, the BesTime Ensemble Timing Generator continuously collects full timing statistics on each input with respect to the output timing signal. These statistics can be used to verify the performance of the TimeSource 2500, or detect a timing problem on an incoming reference.

Figure 3. TimeSource 2500 Block Diagram

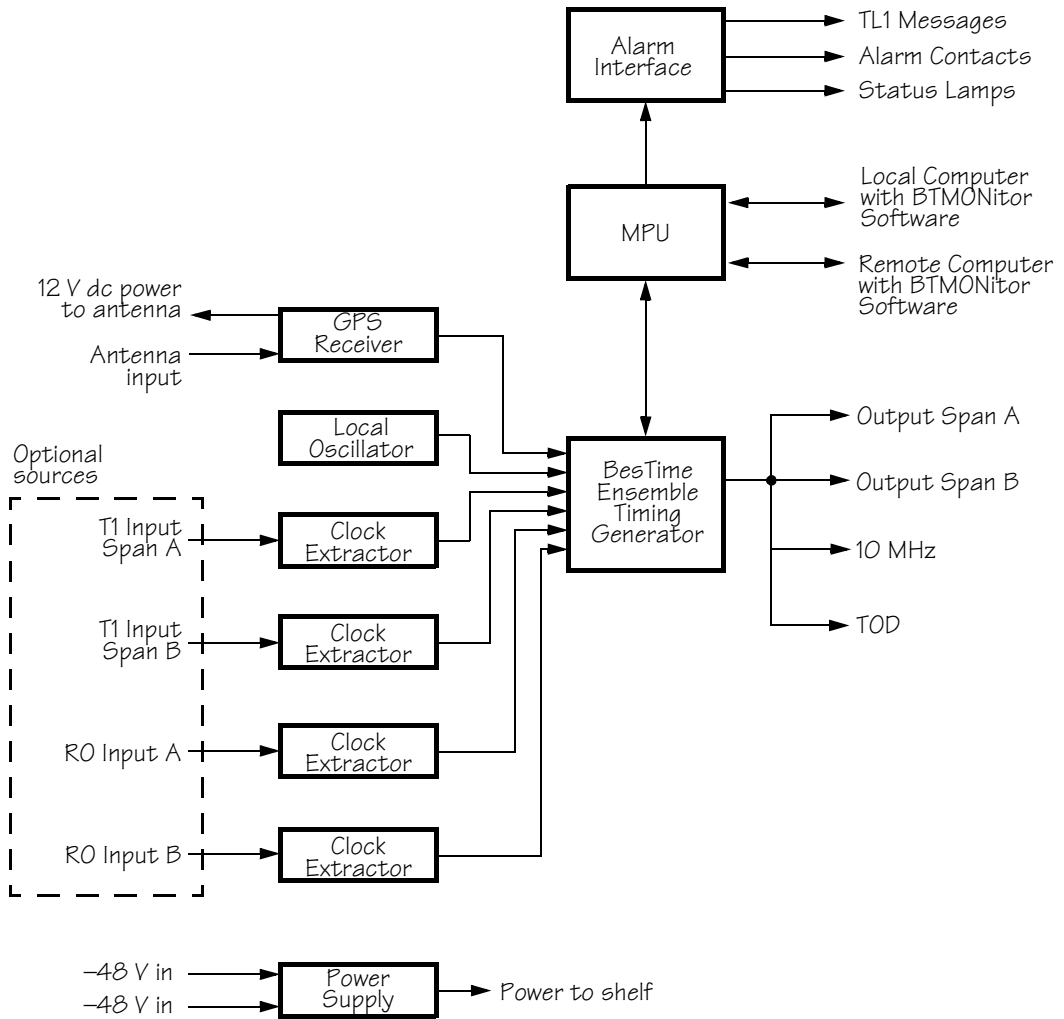

Antenna

The standard antenna is a right-hand circular polarized volute antenna with a built-in amplifier that provides 23 dB of signal gain.

The high-gain antennas are right-hand circular polarized antennas with built-in amplifiers that provide 40 dB or 50 dB of signal gain.

A single cable provides 12 volts dc power from the shelf, and transports GPS satellite L1-band signals to the shelf.

GPS Receiver

The GPS Receiver continuously tracks up to eight satellites, using both carrier and code lock. The recovered pseudo-range measurement data is processed to determine precise time and frequency state estimates for the local oscillator. The receiver software is optimized to track and update state estimates when as few as one satellite is in view.

Local Oscillator

A rubidium oscillator, based on a digitally controlled servo-loop, provides an ultra-stable local oscillator signal, which is sent to the BesTime Ensemble Timing Generator.

Clock Extractors

T1 signals (bridged or terminated) and remote oscillator signals can enter on the Input Span A and B connectors. These optional inputs can be monitored, or used as back-up inputs to the system in case of a long-term loss of GPS input. A Clock Extractor circuit extracts a clock from each of these signals, and sends the clocks to the BesTime Ensemble Timing Generator.

Power Supply

A power converter filters and converts -48 volt dc power supplied to the shelf into the voltages required by the shelf. Dual power feeds are supplied through the Power A and B connectors.

BesTime Ensemble Timing Generator

Clock signals from the GPS Receiver, a local oscillator, optional T1 span lines, and optional 5 MHz remote oscillators are used as sources by the BesTime algorithms in the Ensemble Timing Generator. The signals are analyzed for MDEV, TDEV, MTIE, and other phase and frequency characteristics.

The BesTime Ensemble Timing Generator uses standard statistical clock models to analyze each input signal and synthesize highly stable output timing signals.

T1 Output

The BesTime Ensemble Timing Generator provides the timing for the T1 timing signals available at the Output Span A and B connectors in a framed, all-ones format, which is selectable in either D4 or ESF framing. SSM is available with ESF framing.

10 MHz Output

The BesTime Ensemble Timing Generator provides the timing for the 10 MHz low-phase-noise timing signal, available at the 10 MHz Output connector, which can be used for local cellular frequency or testing purposes.

TOD Output

The BesTime Ensemble Timing Generator provides the timing for the TOD timing signal available at the TOD connector, which provides time code to devices compatible with NTP Type 4 or Cisco format. A 1 pps signal is also available at the TOD connector.

BTMONitor Software

BTMONitor (BesTime Monitoring) is a Windows 95/98/NT compatible craft software program which provides system configuration, alarms, and diagnostics. BTMONitor resides on a user-provided PC, and interfaces to the TimeSource 2500 Shelf via the local (Craft) RJ-45 or remote (Remote) RS-232 communication port.

Alarm Interface

The MPU delivers major and minor alarms to dry-contact type connections at the Alarms connector. Alarms are also indicated by the front-panel status lamps, BTMONitor application, which provides extensive reports of alarm and status, and TL1 messages reported via the Craft communication port.

Engineering & Ordering

This chapter provides antenna installation guidelines, shelf mounting configurations, computer requirements, parts lists, and a list of user-supplied tools required for installation.

Site Survey

A site survey should be performed before ordering the system, as described in Procedure A.

Procedure A. Site Survey

Step	Action
1	Determine the location of the grounding point for the lightning suppressor. The lightning suppressor must be located within 15 ft of this point. If the grounding point is inside the building, the grounding point must be within 50 cable ft of where the antenna cable enters the building. Valid lightning suppressor grounding points are as follows: <ul style="list-style-type: none">• Valid roof ring ground system• Cad weld to building structure steel• Central Office ground plate
2	Determine the best location for mounting the antenna. The ideal location is where the antenna has an unobstructed view of the sky, from the horizon to zenith, for 360° around the horizon.
3	Determine the shelf location.
4	Determine the cable length between the antenna, and the lightning suppressor location determined in Steps 1 and 3.
5	Determine the cable length between the lightning suppressor and the shelf location determined in Steps 1 and 3.
6	Determine the -48 volt power source for the shelf.

Lightning Suppressor Guidelines

- Mount the lightning suppressor within 15 feet of a valid, direct, low impedance, low resistance, earth ground connection point. Valid earth grounds include the roof ring ground system, building structural steel, or a Central Office ground plate. If the grounding point is inside the building, mount the suppressor within 50 feet of the cable entry into the building.

Warning: Metal clamps that form a complete metal circle around the antenna cable or the cable conduit are not allowed. The ring clamp acts like a choke coil to induced currents, which resists current flow and hampers proper lightning protection.

Warning: Place the lightning suppressor away from electrical devices or cabling that may induce arcing.

Note: Keep all impedances as low as possible, otherwise the grounding scheme may be defeated.

- Route the ground wire as straight as possible (bends in the ground wire increase impedance at lightning frequencies), in accordance with local company practices.
- Treat all exposed connections with an electrically conductive anti-corrosion compound (Kopr-Shield or equivalent).

Warning: Avoid small-radius turns and unnecessary turns.

Antenna Location Guidelines

DANGER: Do not select an antenna location that could be an electrical or physical hazard to work persons or equipment. Avoid proximity to all high-voltage sources. Mount in an easily maintainable location.

The ideal antenna location provides a clear, unobstructed view of the sky from the zenith to the horizon line, and 360 degrees around the horizon.

A compromise often must be made between location and satellite field of view. The smaller the field of view, the fewer the number of satellites that can be used in the timing solution for GPS derived time.

Signals closer to the horizon are often subject to multipath effects, which degrade the timing solution. The TimeSource 2500 can be set to ignore, or mask, all signals from the horizon to a chosen angle of elevation (mask angle). (See Figure 4.)

Due to the geometry of the GPS satellite orbits, more satellites are visible in the direction of the equator than the poles. If possible, place the antenna so that the antenna has a clear view toward the equator (toward the south in the northern hemisphere, or toward the north in the southern hemisphere). Up to 60 degrees of arc, centered at the pole, may be blocked with little effect in the temperate latitudes. This guideline is less applicable in latitudes nearer the equator.

Figure 4. Antenna Field of View

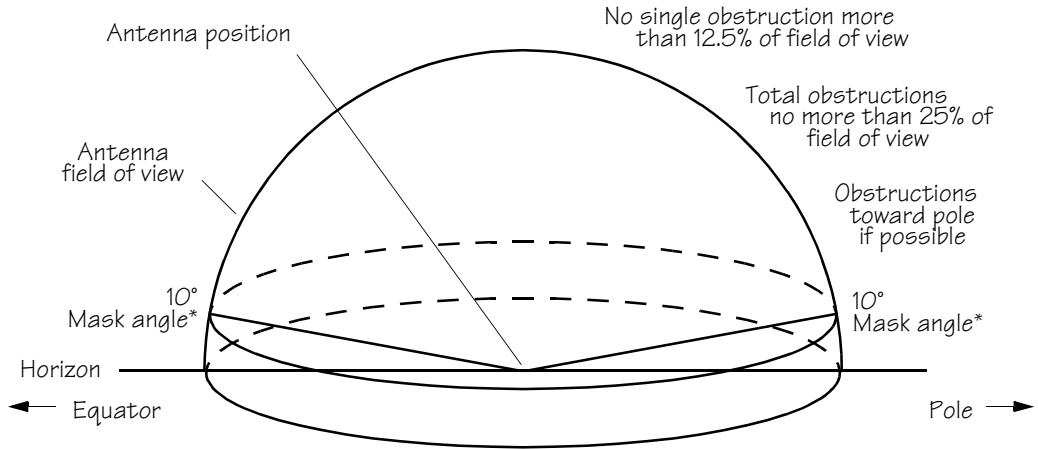

* An angle of 10° masks objects up to about 3.5 ft above the horizon at 20 ft from the antenna (illustration at right.)

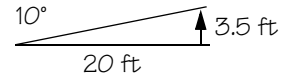

Observe the following guidelines during the placement and installation of the antenna:

- Total of obstructions above the mask angle should not obscure more than 25 percent of the total field of view (90 degrees of azimuth) (Figure 5).
- No single obstruction should block more than 12.5 percent of the view (45 degrees of azimuth).

Notes:

1. Place the antenna high enough on the tower that obstructions are below the mask angle; mount the antenna more than 3 feet away from the tower, and far below the interference of the antennas at the top of the tower. Tower mounting is the least desirable location because of the potential for severe multipath, and difficulty in troubleshooting and maintenance.
2. Place the antenna high enough that the roof structure and tree are below the mask angle, and the water tower does not block more than 12.5 percent of the sky.

Figure 5. Antenna Location Example

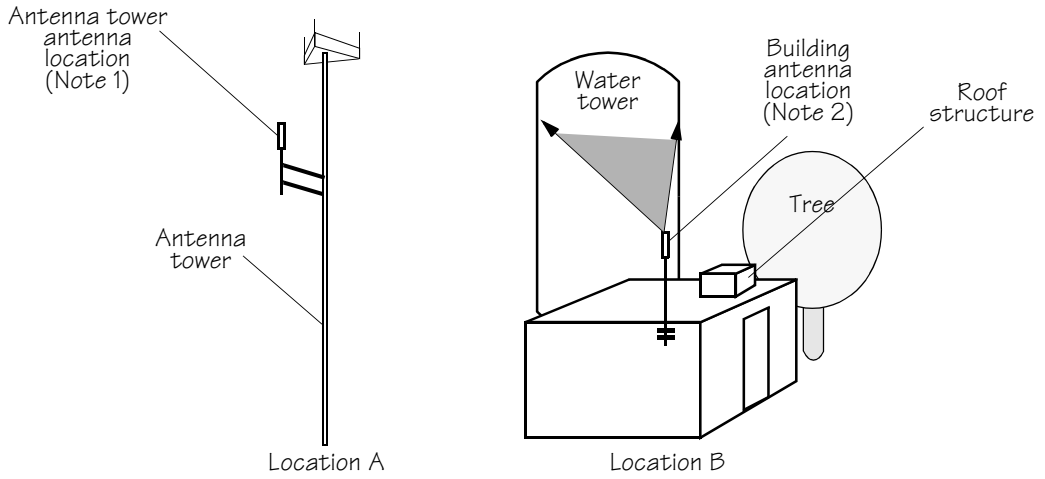

2

Note: The most important objects are within 1/4 mile (400 yards) of the antenna. Obstructions may include, but are not limited to, towers, buildings, other construction, trees, and high-voltage power lines.

- Be aware of transmitting antennas in the area. The direction of transmission, power level, and frequency may cause interference.
- The recommended horizontal distance from other receiving antennas is 3 feet.
- The recommended horizontal distance from vertical reflective structures (e.g., heating ducts, equipment housings, etc.) is twice the height of the structure, or 10 feet (Figure 6).

Figure 6. Sample Rooftop Antenna Mount

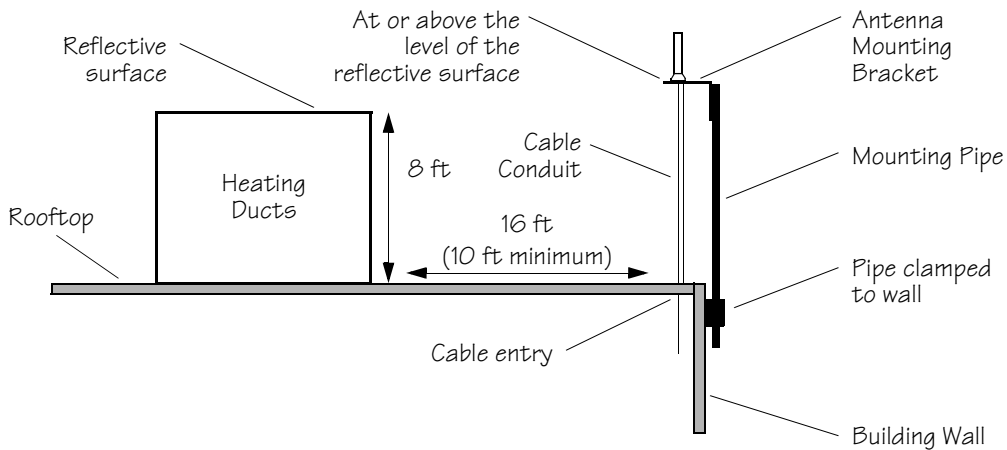

Note: This is an example only. Not all parts are available from Symmetricom.

-
- The recommended vertical distance above parapets, obstructions, or horizontal metallic reflective surfaces is 4 feet.
 - Try to avoid locating the antenna within 30 degrees azimuth of the transmission direction of any transmitting antenna (to avoid overpowering the GPS reception, even though the transmitting antenna may operate at a different frequency).
 - Try to avoid locating the antenna underneath high power lines. If this cannot be avoided, ensure the antenna is placed at least twice as far from the power line as the power line is high (to avoid danger to personnel and multipath effects).
 - Mount the antenna in a location with easy and safe access for future maintenance purposes.
 - Mount the antenna on a mast of 1 inch diameter galvanized metal pipe (recommended). Do not use metal as a cable conduit.

Cabling Considerations

The antenna assembly uses the same coaxial cable for power and antenna signals. The length of cable is determined by circumstances of the installation and site, and the type of antenna (standard or high-gain) used.

Cables must be run as straight as possible. All cables should be routed in accordance with local company practices.

Note: Keep all impedances as low as possible, otherwise the grounding scheme may be defeated.

Observe the following guidelines during the placement and installation of the cables:

- Route cables as straight as possible (bends in the cable increase impedance at lightning frequencies), in accordance with local company practices.
- Any opening where conduit enters the building must be waterproofed per local company practices.
- Treat all exposed connections with an electrically conductive anti-corrosion compound (Kopr-Shield or equivalent).

Warning: **Avoid small-radius turns and unnecessary turns.**

Cabling for Standard Antennas

100 Foot Maximum Antenna-to-Shelf Cabling

When the total length of the cable route is 100 feet or less, only LMR-240 cable is required. (LMR-400 cable may optionally be used.) If two 50 foot LMR-240 cables will be used, the 093-31240-10 LMR-240 cable kit is recommended; if varying LMR-240 cable lengths will be used, the 093-31241-10 LMR-240 cable kit is recommended.

Figure 7 shows the antenna-to-shelf cabling if using the 093-31240-10 LMR-240 cable kit; Figure 8 shows the antenna-to-shelf cabling if using the 093-31241-10 LMR-240 cable kit.

Notes:

1. The lightning suppressor may be placed inside or outside the building, whichever is closest to a valid earth ground. If the lightning suppressor is inside the building, Symmetricom recommends placement no more than 50 feet from the cable entry point. If the lightning suppressor is outside the building, Symmetricom recommends the suppressor be inside a weatherproof enclosure.
2. Dashed lines indicate where various factory-ordered parts apply.
3. Use 4 AWG or larger ground cable, if greater than 6 feet to valid earth ground; otherwise, use 6 AWG cable. Run the cable as straight and direct as possible, no more than 15 feet from the grounding point.
4. Cables may have to be cut to length and have connectors attached, to accommodate installation and site specifications. An LMR-240 cable stripper (154-00021-01) and LMR-240 crimp tool (154-00022-01) are available as options, for installations in which the cable must be cut to length. Contact Symmetricom Inside Sales Department for ordering information.

Figure 7. Standard Antenna-to-Shelf Cabling with LMR-240 Cable (100 Feet Maximum)

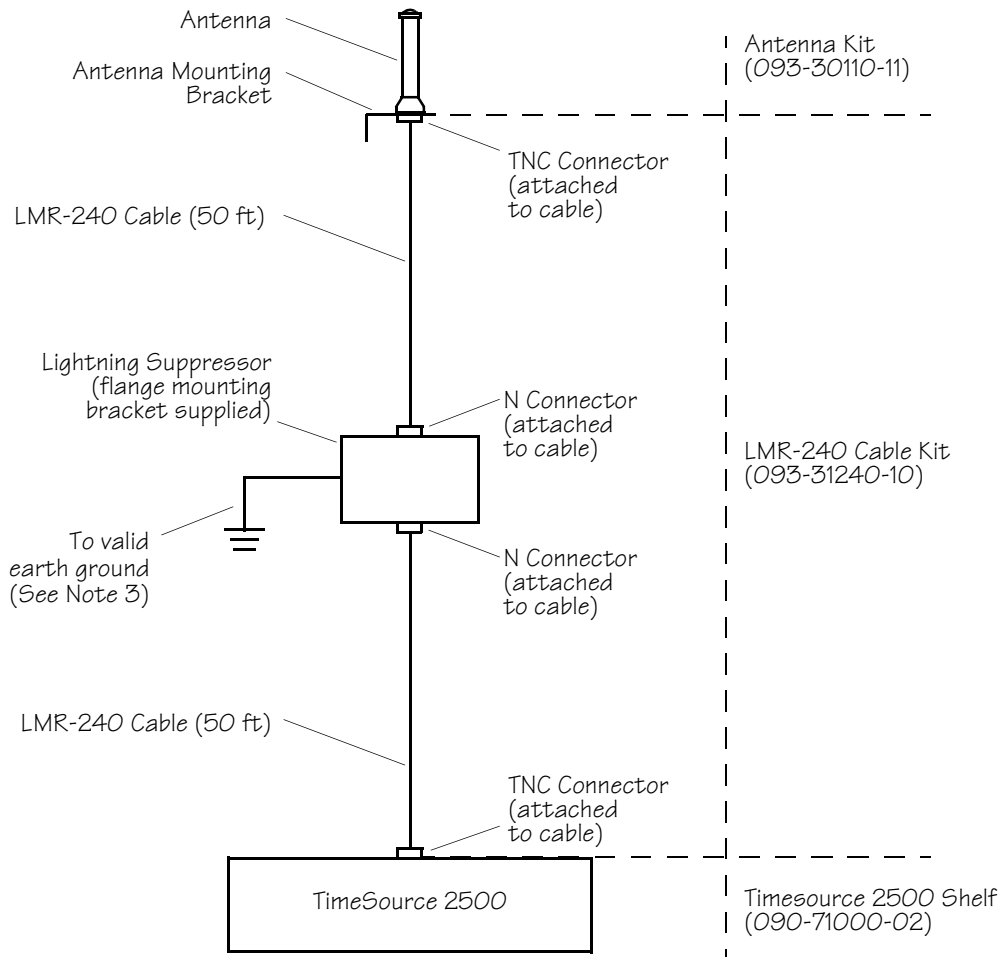
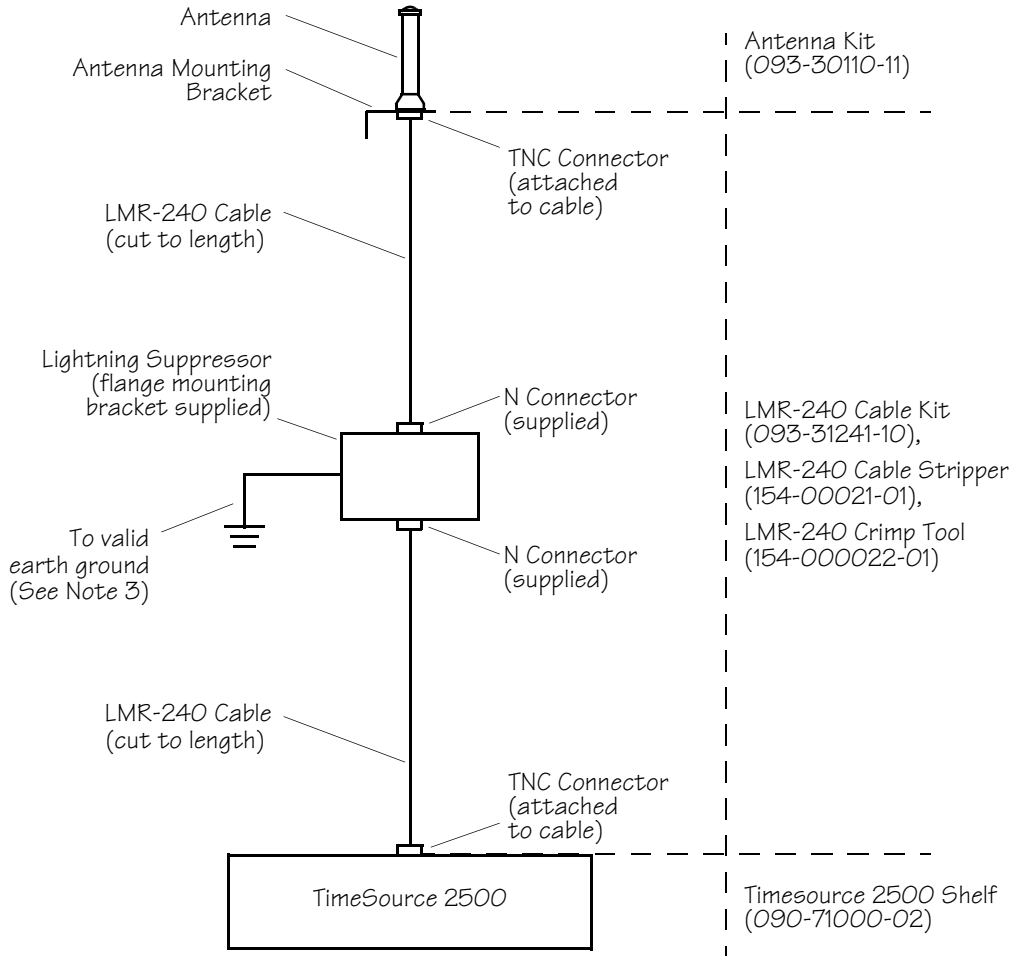

Figure 8. Standard Antenna-to-Shelf Cabling with LMR-240 Cable (Varying Lengths)
(100 Feet Maximum)



100–200 Foot Antenna-to-Shelf Cabling

Figure 9 shows the antenna-to-shelf cabling when the total length of the cable route exceeds 100 feet. In this instance, LMR-400 cable, in addition to LMR-240 cable, is required.

For this configuration, the following are recommended:

- LMR-400 cable kit for 150 feet cable (093-31400-15) or 200 feet cable (093-31400-20)
- Crimp kit (093-31000-01)

Notes:

1. The lightning suppressor may be placed inside or outside the building, whichever is closest to a valid earth ground. If the lightning suppressor is inside the building, Symmetricom recommends placement no more than 10 feet from the cable entry point. If the lightning suppressor is outside the building, Symmetricom recommends the suppressor be inside a weatherproof enclosure.
2. Dashed lines indicate where various factory-ordered parts apply.
3. Use 4 AWG or larger ground cable, if greater than 6 feet to valid earth ground; otherwise, use 6 AWG cable. Run the cable as straight and direct as possible.

Figure 9. Standard Antenna-to-Shelf Cabling with LMR-240 and -400 Cable (100–200 Feet)

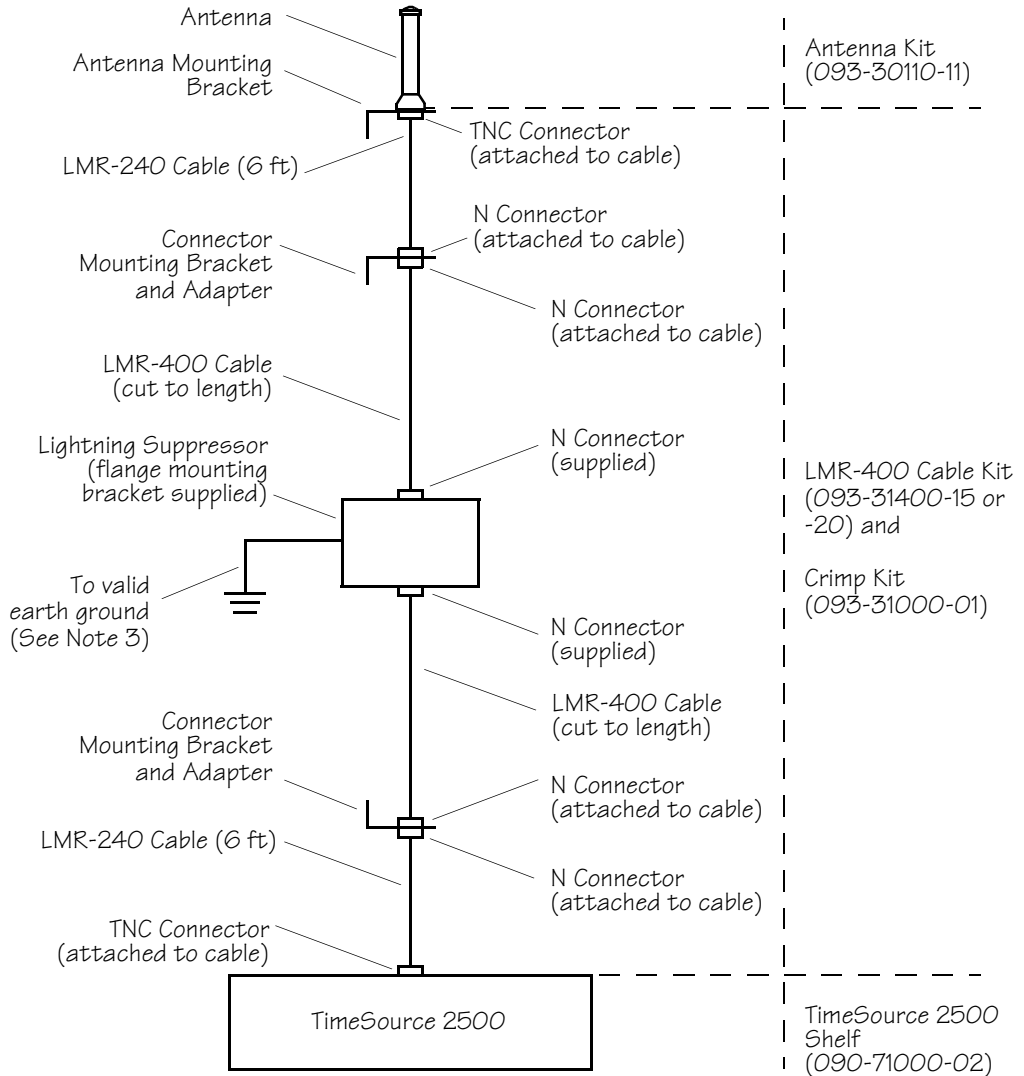

Cabling for High-Gain Antennas

Use Table A to determine the appropriate cable kit and antenna kit.

Table A. High-Gain Antenna and Cable Guide

Cable Kit Part Number	Cable Type	Min./Max. Length (ft)	Antenna Kit Part Number	dB	Reference Figure
093-31240-20	LMR-240	100–200	093-30110-12	+40	10
093-31240-35	LMR-240	200–350	093-30110-13	+50	11
093-31400-40	LMR-400	200–400	093-30110-12	+40	12
093-31400-60	LMR-400	400–600	093-30110-13	+50	13
093-31400-70	LMR-400	400–700	093-30110-13	+50	14

For cable kits 093-31240-20 and 093-31240-35, the following items are recommended:

- LMR-240 cable stripper (154-00021-01)
- LMR-240 crimp tool (154-00022-01)

For cable kits 093-31400-40, 093-31400-60, and 093-31400-70, the universal crimp kit (093-31000-01) is recommended.

Notes:

1. The lightning suppressor may be placed inside or outside the building, whichever is closest to a valid earth ground. If the lightning suppressor is inside the building, Symmetricom recommends placement no more than 10 feet from the cable entry point. If the lightning suppressor is outside the building, Symmetricom recommends the suppressor be inside a weatherproof enclosure.
2. Dashed lines indicate where various factory-ordered parts apply.
3. Use 4 AWG or larger ground cable, if greater than 6 feet to valid earth ground; otherwise, use 6 AWG cable. Run the cable as straight and direct as possible.

Figures 10 through 14 show antenna-to-shelf cabling for high-gain antennas.

Figure 10. +40 dB Antenna-to-Shelf Cabling with LMR-240 Cable (100–200 Feet)

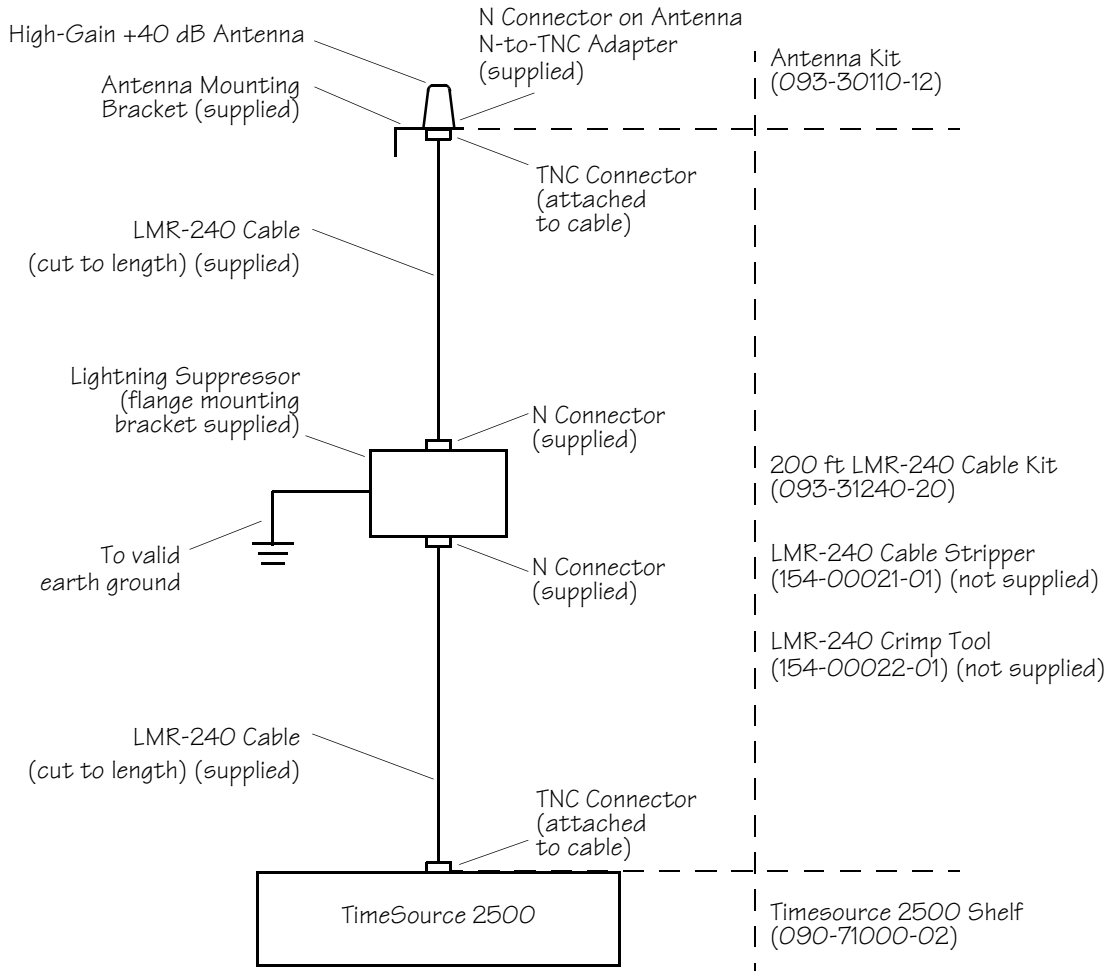

Figure 11. +50 dB Antenna-to-Shelf Cabling with LMR-240 Cable (200–350 Feet)

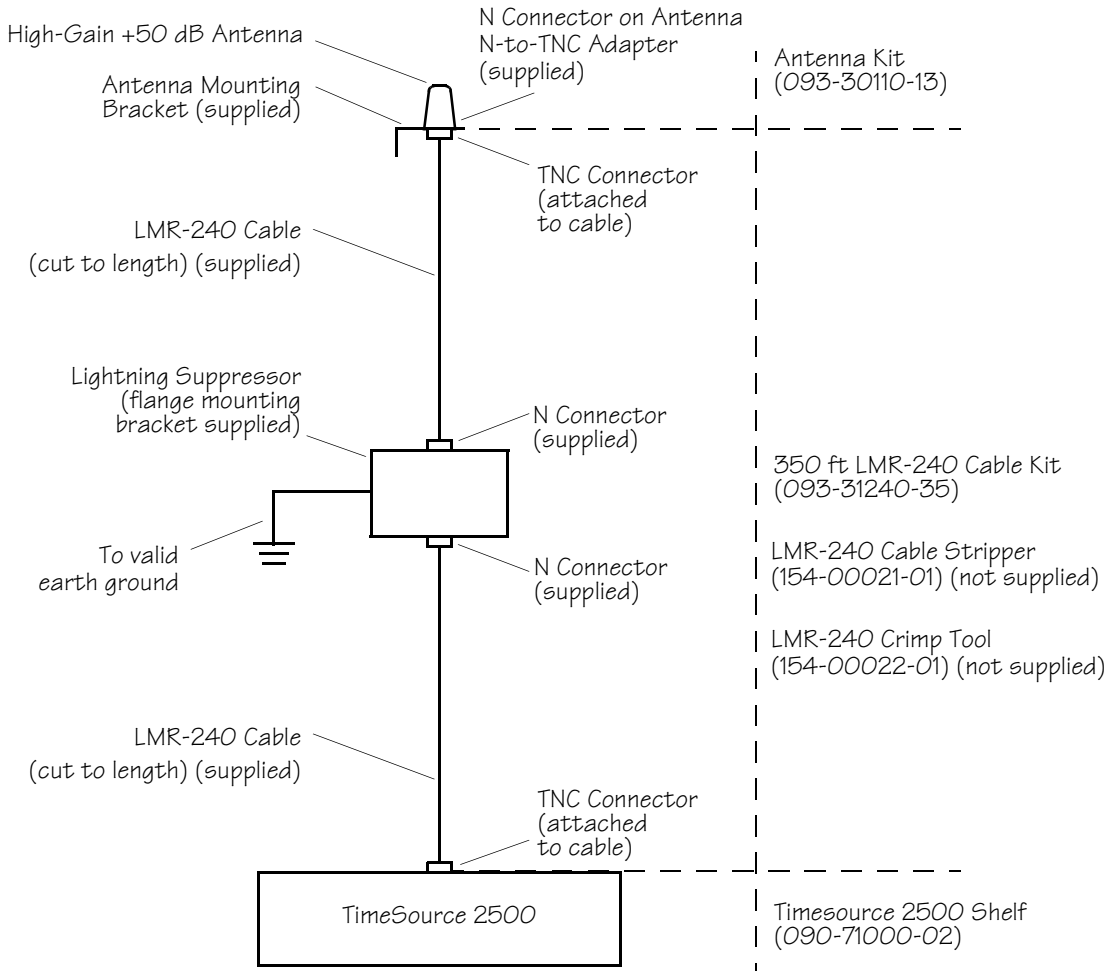

Figure 12. +40 dB Antenna-to-Shelf Cabling with LMR-240 and -400 Cable (200–400 Feet)

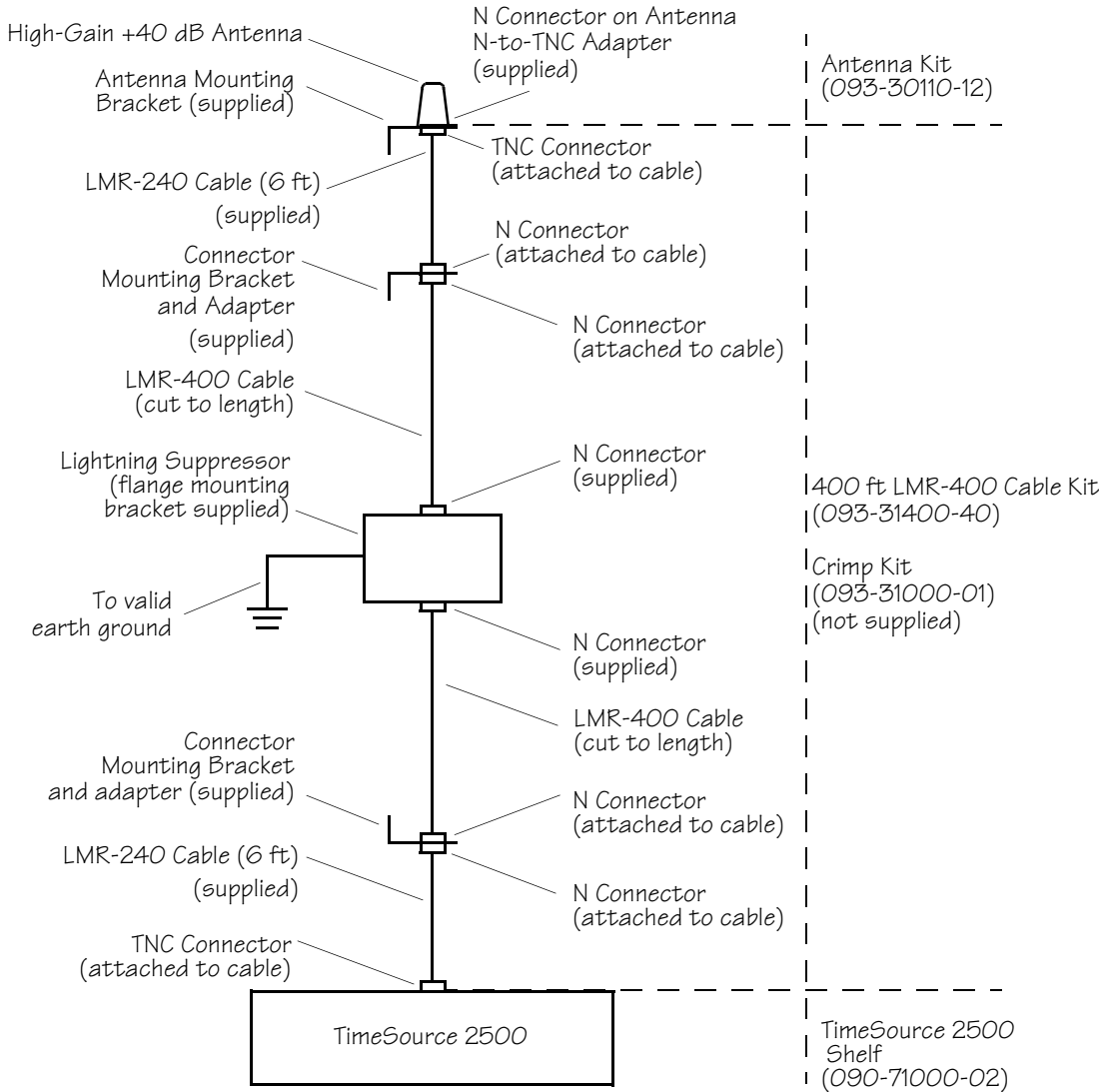

Figure 13. +50 dB Antenna-to-Shelf Cabling with LMR-240 and -400 Cable (400–600 Feet)

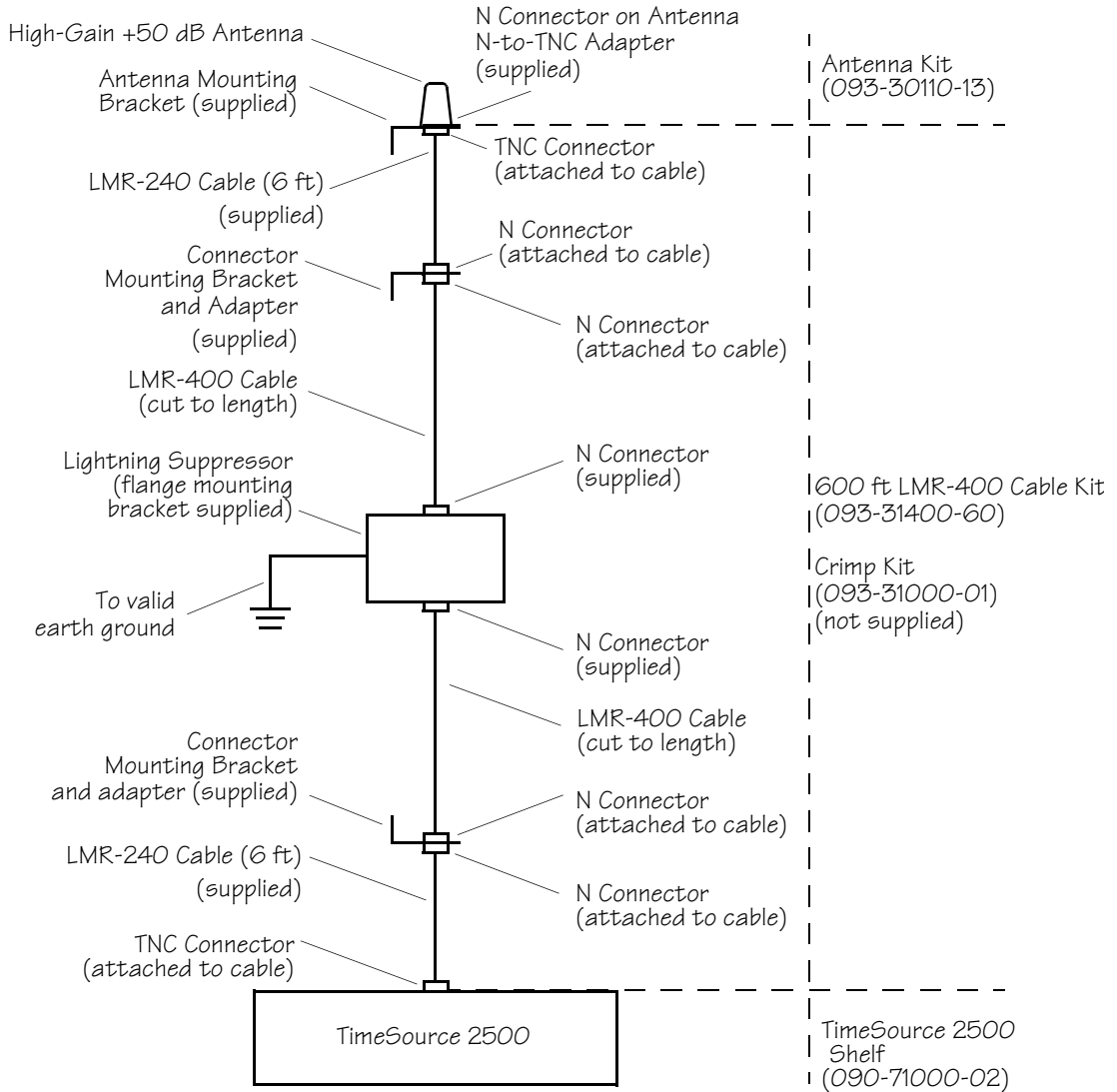
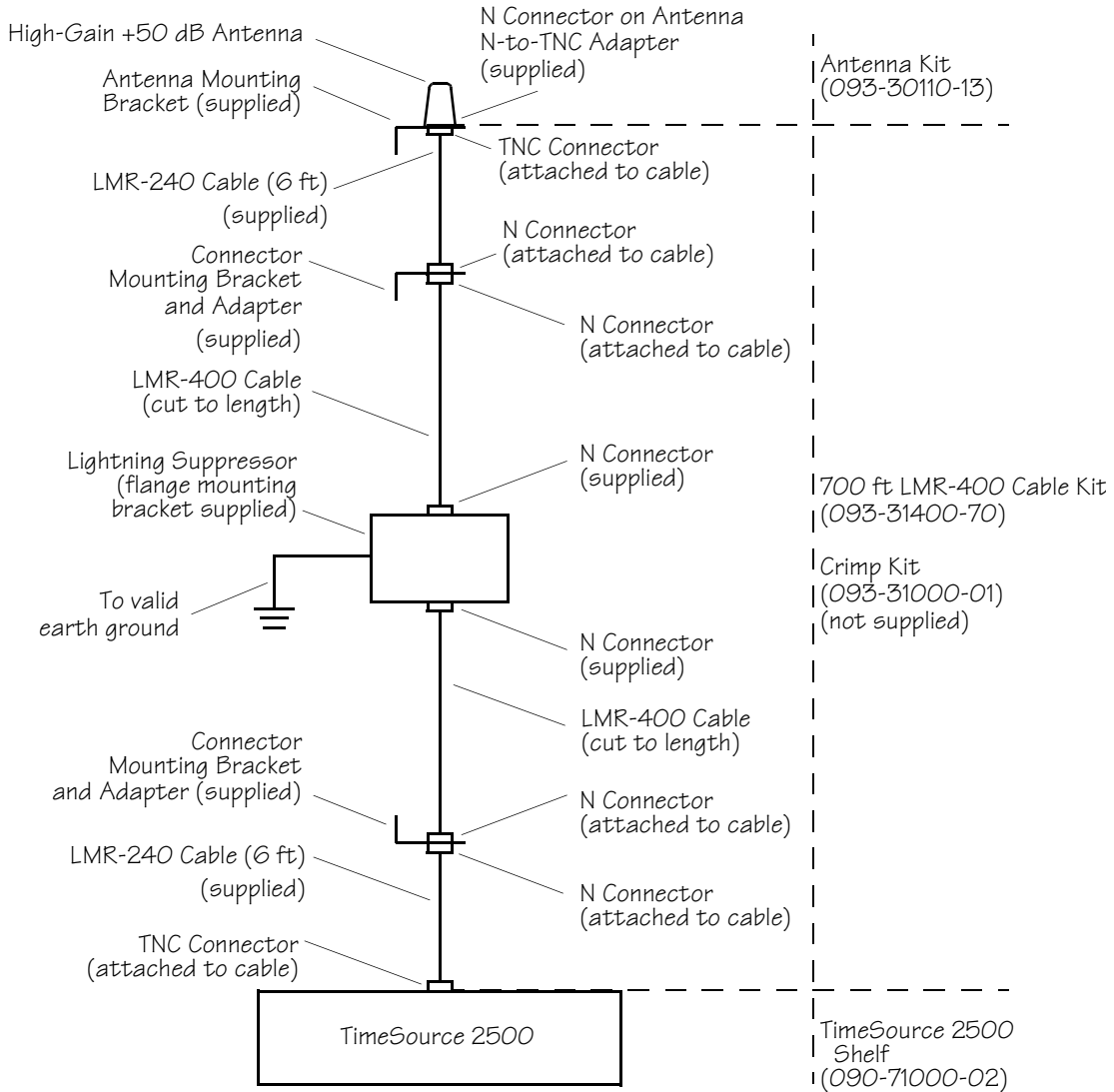

Figure 14. +50 dB Antenna-to-Shelf Cabling with LMR-240 and -400 Cable (400–700 Feet)



Shelf Considerations

Rack Mounted

The TimeSource 2500 Shelf can be mounted in either a 19 inch or 23 inch rack. Supplied mounting ears can be positioned for flush or 5 inch offset mounting. Allow for two RUs (3-1/2 inches) of vertical space on the rack, per shelf.

To make power, input, output, and alarm connections from the rear of the rack, instead of the front of the shelf, a wire-wrap panel is available separately, as an option. The wire-wrap panel can be mounted below a rack-mounted shelf, in either a 19 inch or 23 inch rack. Mounting ears (supplied with the option) can be positioned for flush or 5 inch offset mounting. Allow for two RUs (3-1/2 inches) of vertical space on the rack, per wire-wrap panel.

Wall Mounted

The TimeSource 2500 can be attached to a wall or other surface by ordering the appropriate wall-mount configuration option.

Computer Requirements

A user-supplied computer is required to operate the TimeSource 2500 System. Minimum requirements are as follows:

- Operating system: Windows 95, Windows 98, or Windows NT 4.0
- CPU: x486 or equivalent, at 33 MHz
- RAM: 8 MB
- Serial communications port
- 3-1/2 inch floppy disk drive
- Recommended: spreadsheet application that can accept comma-delimited (.csv) data files, to process the logged files

Ordering Information

Shelves

Rack-Mounted

With Antenna

The rack-mounted TimeSource 2500 (990-71000-06) includes:

- TimeSource 2500 Shelf (090-71000-02)
- Standard antenna kit (093-30110-11) (see “Antenna Kits” for details)
- Hardware kit (093-71000-02)
 - Includes mounting brackets (2 RU) and hardware for mounting in a 19 inch or 23 inch rack
- BTMONitor software (992-71000-01)
- Manual (997-71000-03)
- Cable for connecting the TimeSource 2500 Craft connector to an external personal computer (060-00067-01)

Without Antenna

The optional rack-mounted TimeSource 2500 (990-71000-12) applies if using a high-gain antenna. This system does not include an antenna kit. In this configuration, the shelf is purchased separately from the high-gain antenna kit (093-30110-12 or 093-30110-13). This system includes:

- TimeSource 2500 Shelf (090-71000-02)
- Hardware kit (093-71000-02)
 - Includes mounting brackets (2 RU) and hardware for mounting in a 19 inch or 23 inch rack
- BTMONitor software (992-71000-01)
- Manual (997-71000-03)
- Cable for connecting the TimeSource 2500 Craft connector to an external personal computer (060-00067-01)

Optional Wire-Wrap Panel

The wire-wrap panel (990-71000-11) is available separately, as an option, for the rack-mounted TimeSource 2500. It includes the panel, cables for connecting to the TimeSource 2500, and hardware for mounting in a 19 inch or 23 inch rack.

Wall-Mounted

With Antenna

The wall-mounted TimeSource 2500 (990-71000-07) includes:

- TimeSource 2500 Shelf (090-71000-02)
- Standard antenna kit (093-30110-11) (see “Antenna Kits” for details)
- Hardware kit (093-71000-03)
 - Includes 2 angle brackets and bracket mounting screws (user must supply screws for mounting the shelf to a wall)
- BTMONitor software (992-71000-01)
- Manual (997-71000-03)
- Cable for connecting the TimeSource 2500 Craft connector to an external personal computer (060-00067-01)

Without Antenna

The optional wall-mounted TimeSource 2500 (990-71000-13) applies if using a high-gain antenna. This system does not include an antenna kit. In this configuration, the shelf is purchased separately from the high-gain antenna kit (093-30110-12 or 093-30110-13). This system includes:

- TimeSource 2500 Shelf (090-71000-02)
- Hardware kit (093-71000-03)
 - Includes 2 angle brackets and bracket mounting screws (user must supply screws for mounting the shelf to a wall)
- BTMONitor software (992-71000-01)
- Manual (997-71000-03)
- Cable for connecting the TimeSource 2500 Craft connector to an external personal computer (060-00067-01)

Antenna Kits

The standard antenna kit is included with the 990-71000-06 and 990-71000-07 shelf kits.

There are two optional high-gain antenna kits: one with a 40 dB antenna, and one with a 50 db antenna. In these configurations, the antenna kit is purchased separately from the shelf.

Standard Antenna

The standard antenna kit (093-30110-11) includes:

- Standard antenna (112-00001-02)
- Antenna cable bracket kit (093-00001-01)
 - Includes hardware for mounting antenna

40 dB High-Gain Antenna

The 40 dB high-gain antenna kit (093-30110-12) includes:

- 40 dB high-gain antenna (112-00008-02)
- Antenna cable bracket kit (093-00001-01)
 - Includes hardware for mounting antenna
- N-to-TNC connector adapter (121-00571-01)

50 dB High-Gain Antenna

The 50 dB high-gain antenna kit (093-30110-13) includes:

- 50 dB high-gain antenna (112-00008-03)
- Antenna cable bracket kit (093-00001-01)
 - Includes hardware for mounting antenna
- N-to-TNC connector adapter (121-00571-01)

Antenna Cable Kits

Note: The cable kit for connecting the antenna and the TimeSource 2500 Shelf is available separately, as a specific option for a TimeSource 2500 System.

There are nine antenna-to-shelf cable kits. Order a kit appropriate for your antenna and cabling requirements (refer to Figures 7 through 14 and Table A).

Standard Antenna Cable Kits

Order a kit that equals or exceeds the cable distance required for the installation (refer to Figures 7 through 9):

- LMR-240 cable kit (093-31240-10) for maximum 100 feet antenna-to-shelf cabling with two 50 foot LMR-240 cables, includes:
 - Two 50 foot lengths of LMR-240 cable with N-TNC connectors attached (060-31000-06)
 - Bulkhead-to-flange adapter (125-00044-01) for mounting lightning suppressor
 - Lightning suppressor (143-00016-02)

- LMR-240 cable kit (093-31241-10) for maximum 100 foot antenna-to-shelf cabling with varying LMR-240 cable lengths, includes:
 - One 100 foot length of LMR-240 cable with TNC connectors attached (060-00063-01)
 - Two male N connectors (121-00567-01)
 - Bulkhead-to-flange adapter (125-00044-01) for mounting lightning suppressor
 - Lightning suppressor (143-00016-02)
- LMR-400 cable kit (093-31400-15) for 150 foot maximum antenna-to-shelf cable distance, includes:
 - Two 6 foot lengths of LMR-240 cable with TNC and N male connectors attached (060-00048-01)
 - Connector adapter kit, N female to N female (093-00002-01), for cable transitions between antenna and lightning suppressor
 - Connector mounting bracket kit (093-00001-01) for connector adapter between antenna and lightning suppressor
 - Connector adapter, N female to N female (121-00548-01), between lightning suppressor and shelf
 - Connector mounting bracket (070-00379-02) for connector adapter between lightning suppressor and shelf
 - Two connectors, N male (121-00544-01)
 - 150 feet of LMR-400 cable with N connectors on both ends (060-31000-15)
 - Lightning suppressor (143-00016-02)
 - Bulkhead-to-flange adapter (125-00044-01) for mounting lightning suppressor

-
- LMR-400 cable kit (093-31400-20) for 200 foot maximum antenna-to-shelf cable distance, includes:
 - Two 6 foot lengths of LMR-240 cable with TNC and N male connectors attached (060-00048-01)
 - Connector adapter kit, N female to N female (093-00002-01), for cable transitions between antenna and lightning suppressor
 - Connector mounting bracket kit (093-00001-01) for connector adapter between antenna and lightning suppressor
 - Connector adapter, N female to N female (121-00548-01), between lightning suppressor and shelf
 - Connector mounting bracket (070-00379-02) for connector adapter between lightning suppressor and shelf
 - Two connectors, N male (121-00544-01)
 - 200 feet of LMR-400 cable with N connectors on both ends (060-31000-20)
 - Lightning suppressor (143-00016-02)
 - Bulkhead-to-flange adapter (125-00044-01) for mounting lightning suppressor

40 dB Antenna Cable Kits

Order a kit appropriate for your antenna and cabling requirements (refer to Table A, and Figures 10 and 12).

- LMR-240 cable kit (093-31240-20) for 100 foot to 200 foot antenna-to-shelf cabling and a 40 dB high-gain antenna includes:
 - One 200 foot length of LMR-240 cable with TNC connectors attached (060-00063-02)
 - Two male N connectors (121-00567-01)
 - Bulkhead-to-flange adapter (125-00044-01) for mounting lightning suppressor
 - Lightning suppressor (143-00016-02)

-
- LMR-400 cable kit (093-31400-40) for 200 foot to 400 foot antenna-to-shelf cable distance and a 40 dB high-gain antenna includes:
 - Two 6 foot lengths of LMR-240 cable with TNC and N male connectors attached (060-00048-01)
 - Connector adapter kit, N female to N female (093-00002-01), for cable transitions between antenna and lightning suppressor
 - Connector mounting bracket kit (093-00001-01) for connector adapter between antenna and lightning suppressor
 - Connector adapter, N female to N female (121-00548-01), between lightning suppressor and shelf
 - Connector mounting bracket (070-00379-02) for connector adapter between lightning suppressor and shelf
 - Two connectors, N male (121-00544-01)
 - 400 feet of LMR-400 cable with N connectors on both ends (060-31000-40)
 - Lightning suppressor (143-00016-02)
 - Bulkhead-to-flange adapter (125-00044-01) for mounting lightning suppressor

50 dB Antenna Cable Kits

Order a kit appropriate for your antenna and cabling requirements (refer to Table A, and Figures 11, 13, and 14).

- LMR-240 cable kit (093-31240-35) for 200 foot to 350 foot antenna-to-shelf cabling and a 50 dB high-gain antenna includes:
 - One 350 foot length of LMR-240 cable with TNC connectors attached (060-00063-03)
 - Two male N connectors (121-00567-01)
 - Bulkhead-to-flange adapter (125-00044-01) for mounting lightning suppressor
 - Lightning suppressor (143-00016-02)

-
- LMR-400 cable kit (093-31400-60) for 400 foot to 600 foot antenna-to-shelf cable distance and a 50 dB high-gain antenna includes:
 - Two 6 foot lengths of LMR-240 cable with TNC and N male connectors attached (060-00048-01)
 - Connector adapter kit, N female to N female (093-00002-01), for cable transitions between antenna and lightning suppressor
 - Connector mounting bracket kit (093-00001-01) for connector adapter between antenna and lightning suppressor
 - Connector adapter, N female to N female (121-00548-01), between lightning suppressor and shelf
 - Connector mounting bracket (070-00379-02) for connector adapter between lightning suppressor and shelf
 - Two connectors, N male (121-00544-01)
 - 600 feet of LMR-400 cable with N connectors on both ends (060-31000-60)
 - Lightning suppressor (143-00016-02)
 - Bulkhead-to-flange adapter (125-00044-01) for mounting lightning suppressor

- LMR-400 cable kit (093-31400-70) for 400 foot to 700 foot antenna-to-shelf cable distance and a 50 dB high-gain antenna includes:
 - Two 6 foot lengths of LMR-240 cable with TNC and N male connectors attached (060-00048-01)
 - Connector adapter kit, N female to N female (093-00002-01), for cable transitions between antenna and lightning suppressor
 - Connector mounting bracket kit (093-00001-01) for connector adapter between antenna and lightning suppressor
 - Connector adapter, N female to N female (121-00548-01), between lightning suppressor and shelf
 - Connector mounting bracket (070-00379-02) for connector adapter between lightning suppressor and shelf
 - Two connectors, N male (121-00544-01)
 - 700 feet of LMR-400 cable with N connectors on both ends (060-31000-70)
 - Lightning suppressor (143-00016-02)
 - Bulkhead-to-flange adapter (125-00044-01) for mounting lightning suppressor

Optional Cable Tools

Additional Items for LMR-240 Cable Kit

The following items are available for the LMR-240 cable kit with varying LMR-240 cable lengths.

- LMR-240 cable stripper (154-00021-01)
- LMR-240 crimp tool (154-00022-01)

Additional Item for LMR-400 Cable Kits

The following item is available for LMR-400 cable kits.

- Universal crimp kit (093-31000-01)

User-Supplied Tools and Materials

For Antenna Installation

Ensure that the user-supplied tools and materials listed below are on hand for installation of the antenna.

- 0.375 inch (3/8 inch) open-end wrench (or deep-socket nut-driver)
- 0.25 inch (1/4 inch) open-end wrench (or deep-socket nut-driver)
- Cable cutting tools
- Ground bonding clamps, gutter taps, etc., for connecting 6 AWG (or larger) ground wires to protective and ring ground
- 1 inch diameter galvanized metal pipe, to use as a mast to mount the antenna. Length and type depend on individual installation requirements. Mast should be long enough to position the antenna above any metal object on the roof.
- 6 AWG (or larger) ground wires for grounding the lightning suppressor(s). The wires should be long enough to reach from the lightning suppressor to the building ground. Symmetricom recommends using 6 AWG if the cable distance is less than 100 feet, 4 AWG if the cable distance is greater than 100 feet.
- 1/2 inch diameter PVC conduit for outdoor cables.

- Non-metallic junction box for the lightning suppressor (optional)
- Fire-stopping material to stop fire from passing through conduit hole in roof or wall
- Electrically conductive antioxidant compound (Kopr-Shield or equivalent) to coat any connection exposed to weather, to prevent oxidation
- Ring terminal or spade lug connectors to fit a 6 AWG wire, 0.25 inch wide, and a #6 stud
- Tool for heat-shrinking tubing (for all cable kits except 093-31240-10)
- If antenna-to-shelf cable run is 100 feet or less with varying cable lengths, and crimp tool (154-00022-01) and cable stripper (154-00021-01) are not purchased:
 - LMR-240 cable stripper
 - LMR-240 crimp tool
- If antenna-to-shelf cable run is over 100 feet, and crimp kit (093-31000-01) is not purchased:
 - cable stripper
 - deburring tool
 - side cutters
 - crimp tool for LMR 400 cable

For Shelf Installation

A Phillips-head screwdriver is needed for installing the TimeSource 2500 Shelf in a rack.

.....

Installation

This chapter provides the steps required for installation and power-up.

Chapter 3

Unpacking

Install the TimeSource 2500, using steps in the order given in this chapter. If any difficulties are encountered during the installation process, contact Symmetricom's Customer Technical Assistance Center (CTAC). Refer to the Technical Assistance section of the Troubleshooting chapter for telephone numbers.

CTAC includes Product Technical Support for technical information, and Customer Service for information about an order, RMAs, and other information.

Warning: When handling electronic equipment, use local office procedures regarding electrostatic discharge (ESD), including:

- Use grounded wrist straps connected to equipment frame ground when handling cards.
- Store cards only in antistatic packaging provided by the factory.

Note: Save packing material. All equipment returned *must be packed in the original packing material*. Contact Customer Service if additional packaging is needed.

Unpack equipment carefully; check for completeness against the purchase order. Notify Symmetricom if items are missing.

Inspect equipment for shipping damage, including bent or loose hardware, and broken connectors.

If equipment was damaged in transit, contact Customer Service to request an RMA, and notify the carrier.

Antenna

Installation procedures are to follow local company procedures and the Installation Job Specification.

Prior to installing the antenna, the site, antenna location, lightning suppressor location, cable route, and all other details should be planned.

To install the antenna, refer to Table B, and perform Procedure B.

Warning: Ensure that the lightning suppressor is placed away from electrical devices or cabling that may induce arcing.

Table B. Antenna and Cable Guide

Cable Kit Part Number	Cable Type	Min./Max. Length (ft)	Antenna Kit Part Number	Antenna Type	Reference Figure
093-31240-10	LMR-240	1–100	093-30110-11	Standard	15
093-31241-10	LMR-240	1–100	093-30110-11	Standard	16
093-31400-15	LMR-400	100–150	093-30110-11	Standard	17
093-31400-20	LMR-400	100–200	093-30110-11	Standard	17
093-31240-20	LMR-240	100–200	093-30110-12	+40	18
093-31240-35	LMR-240	200–350	093-30110-13	+50	19
093-31400-40	LMR-400	200–400	093-30110-12	+40	20
093-31400-60	LMR-400	400–600	093-30110-13	+50	21
093-31400-70	LMR-400	400–700	093-30110-13	+50	22

Figure 15. Standard Antenna-to-Shelf Cabling with LMR-240 Cable (100 Feet Maximum)

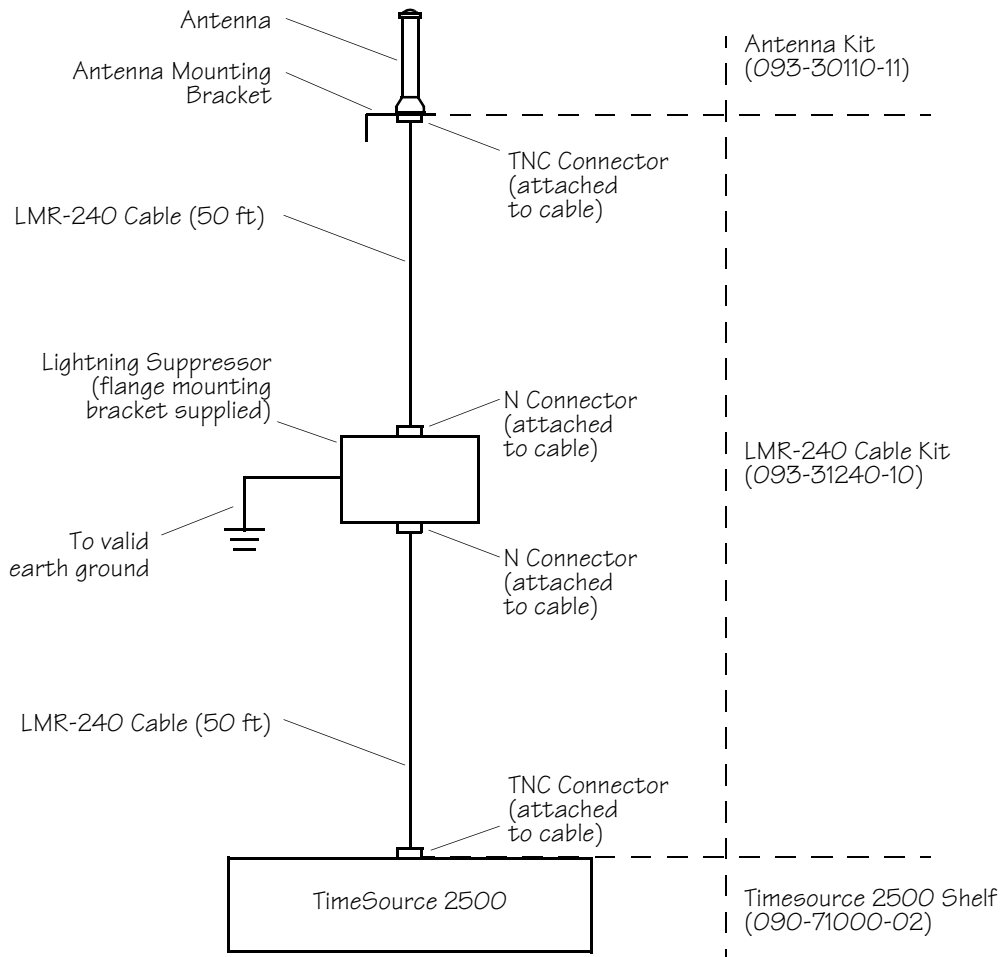
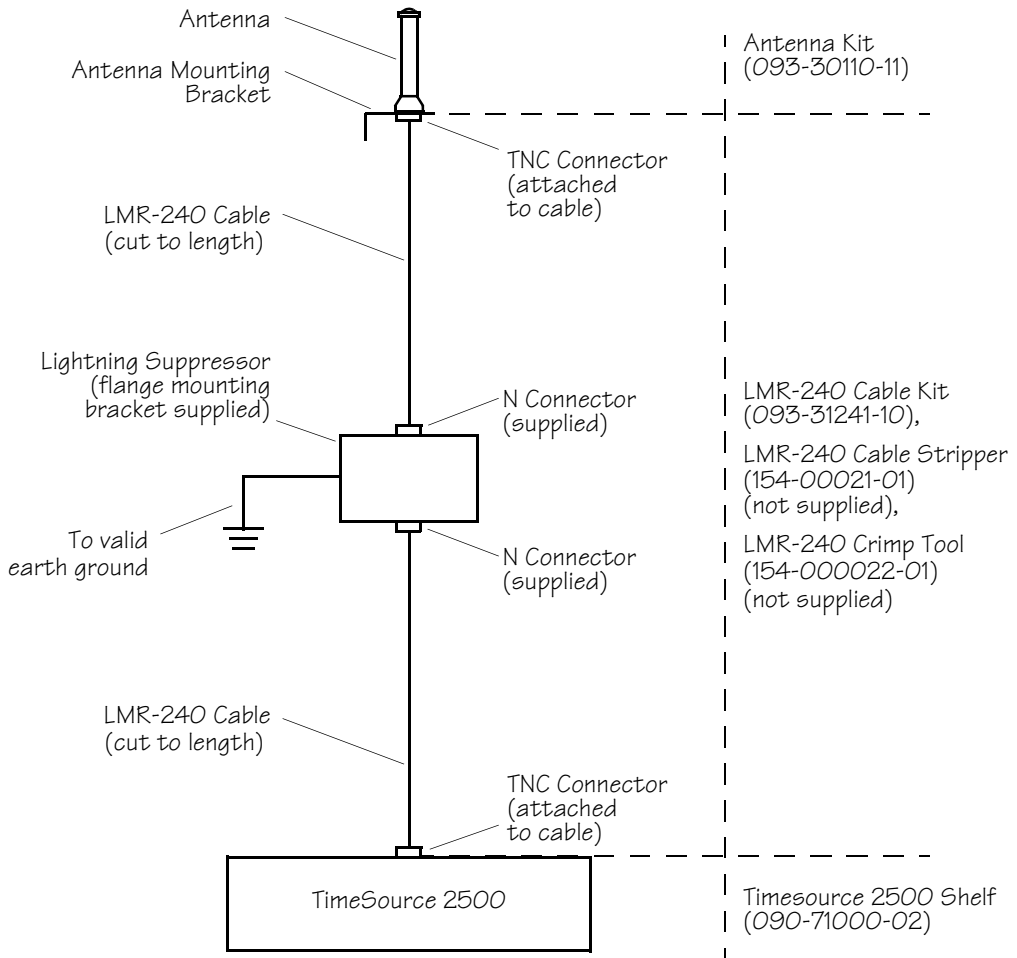

Figure 16. Standard Antenna-to-Shelf Cabling with LMR-240 Cable (Varying Lengths)
(100 Feet Maximum)



3

Figure 17. Standard Antenna-to-Shelf Cabling with LMR-240 and -400 Cable (100-200 Feet)

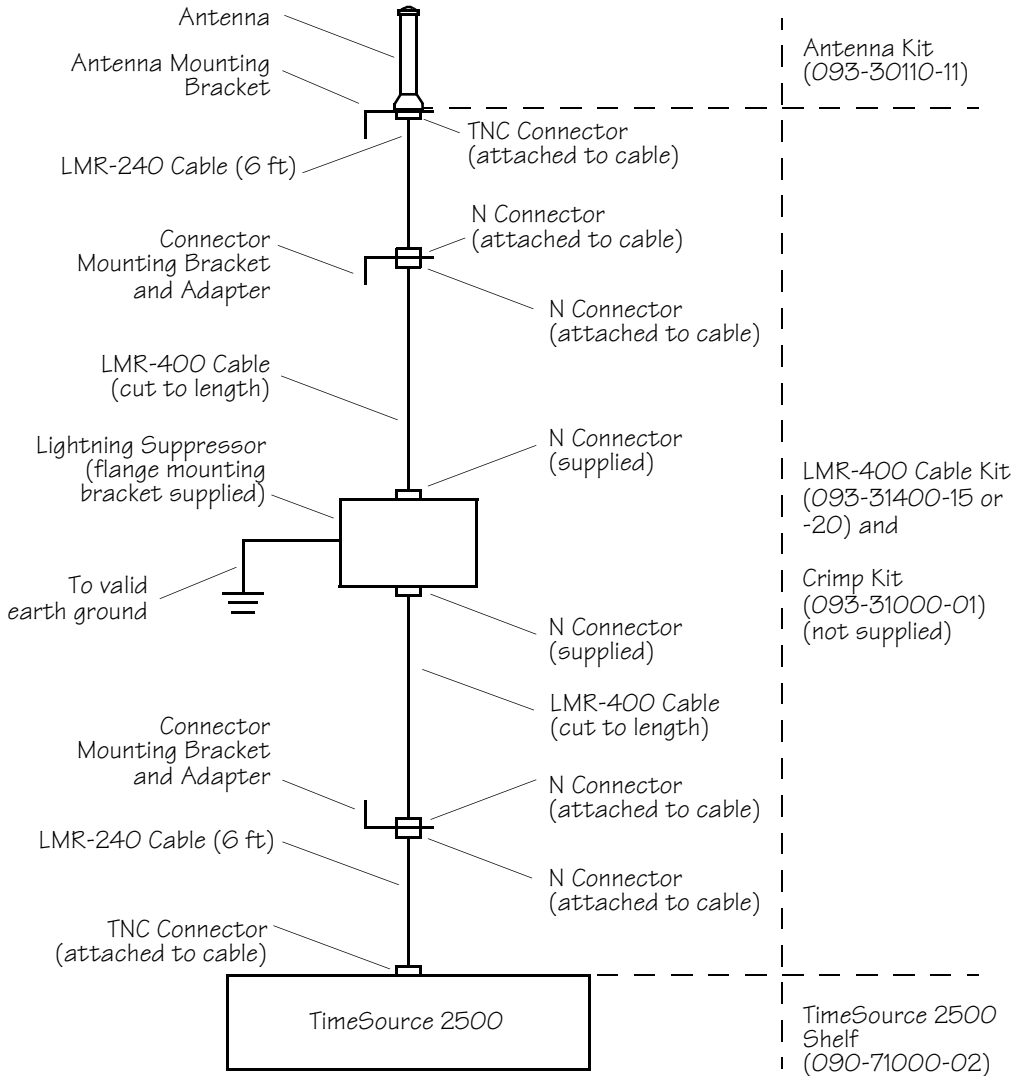
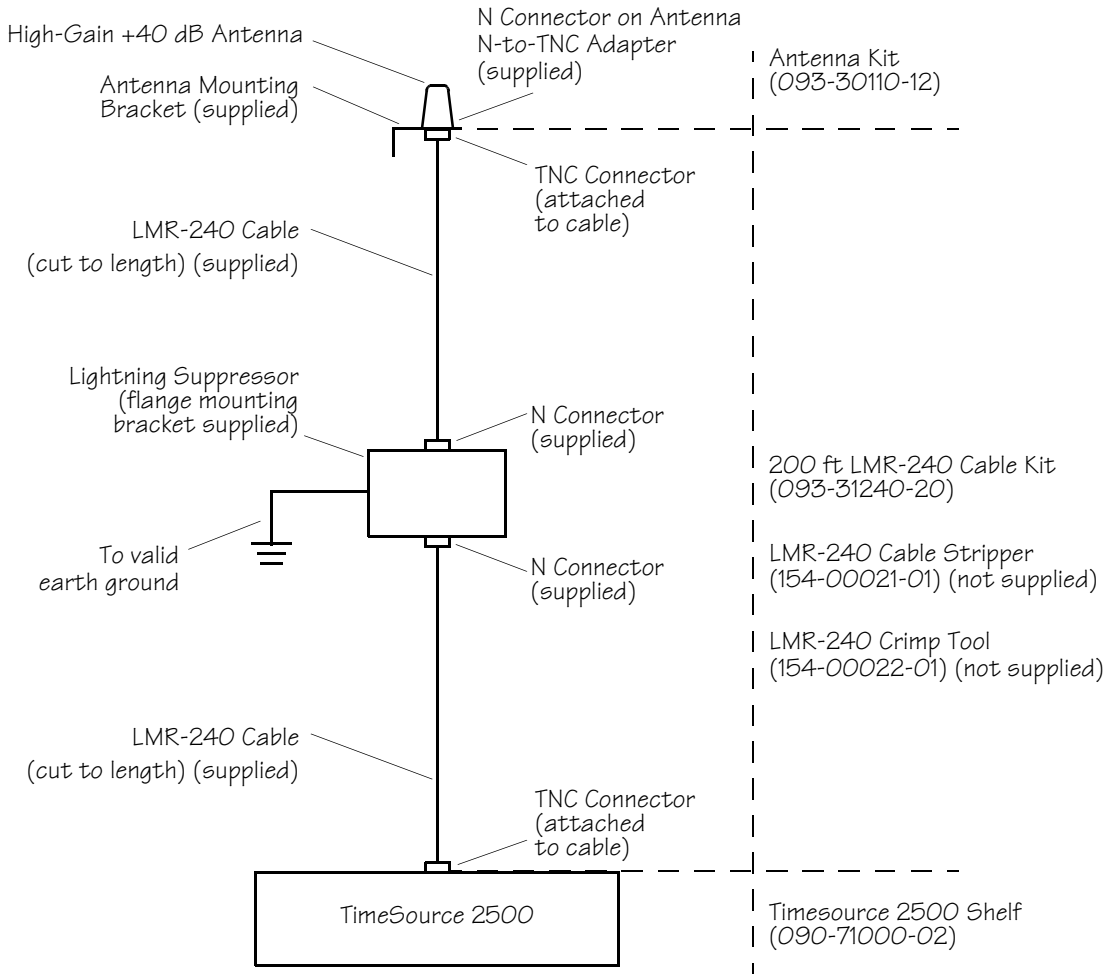

Figure 18. +40 dB Antenna-to-Shelf Cabling with LMR-240 Cable (100–200 Feet)



3

Figure 19. +50 dB Antenna-to-Shelf Cabling with LMR-240 Cable (200–350 Feet)

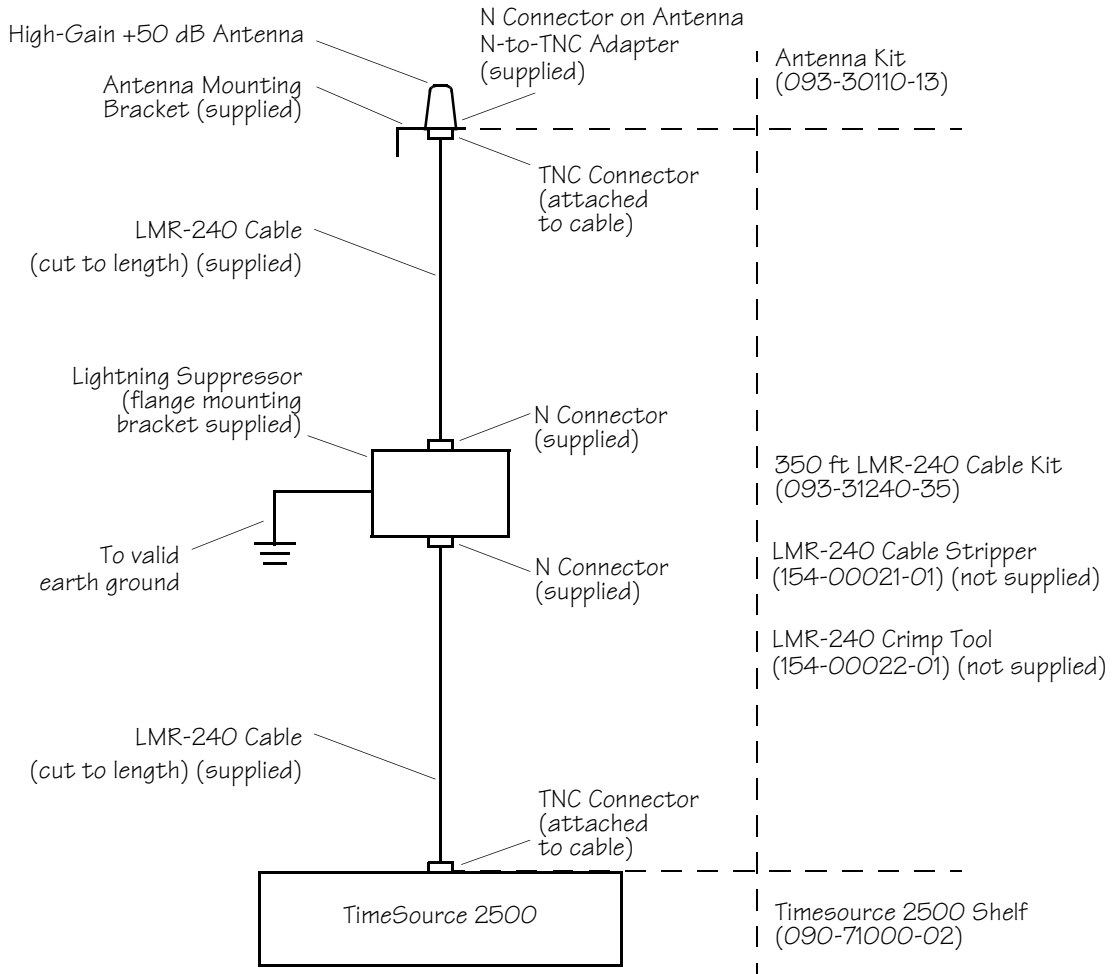

Figure 20. +40 dB Antenna-to-Shelf Cabling with LMR-240 and -400 Cable (200–400 Feet)

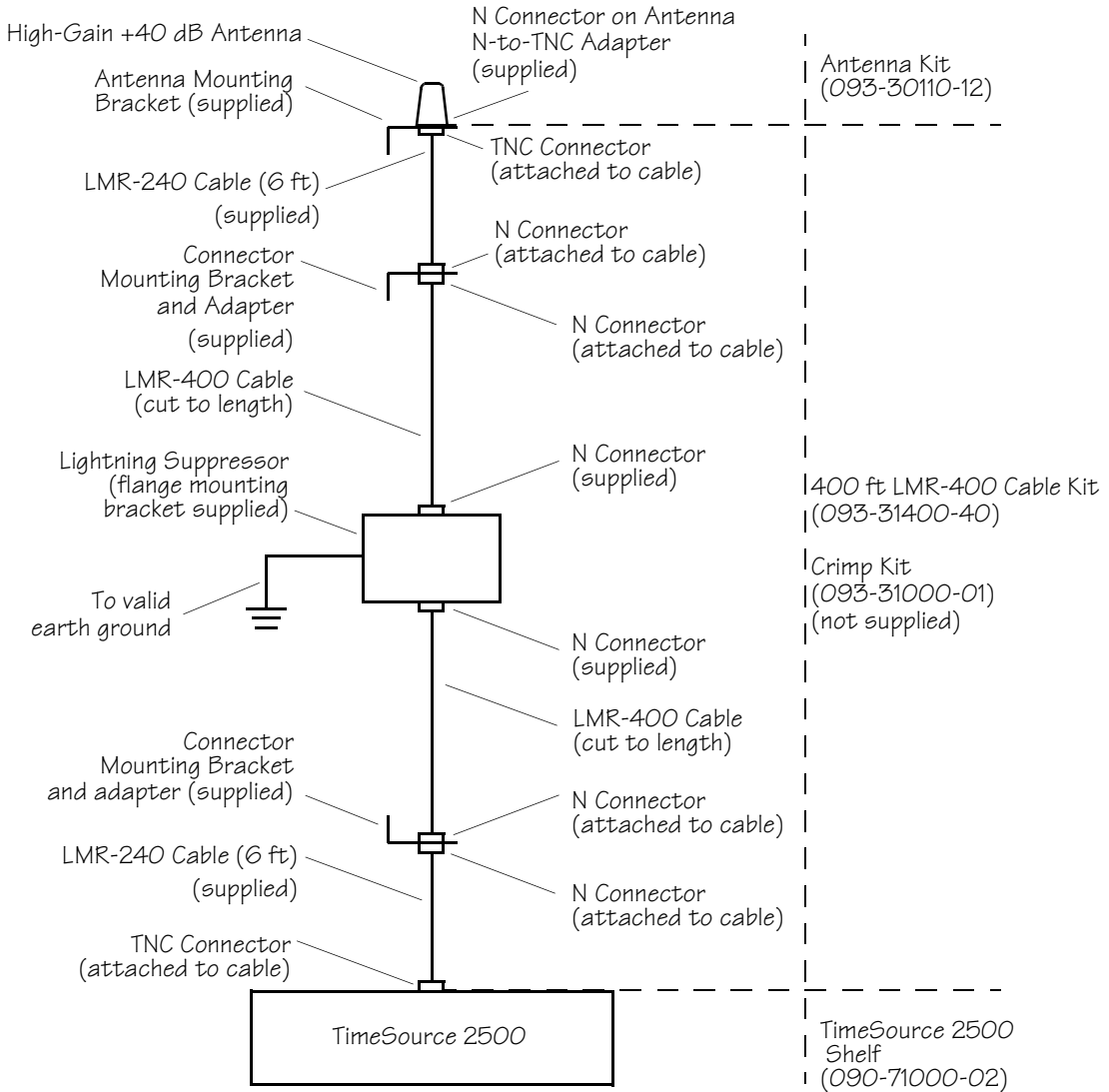

Figure 21. +50 dB Antenna-to-Shelf Cabling with LMR-240 and -400 Cable (400–600 Feet)

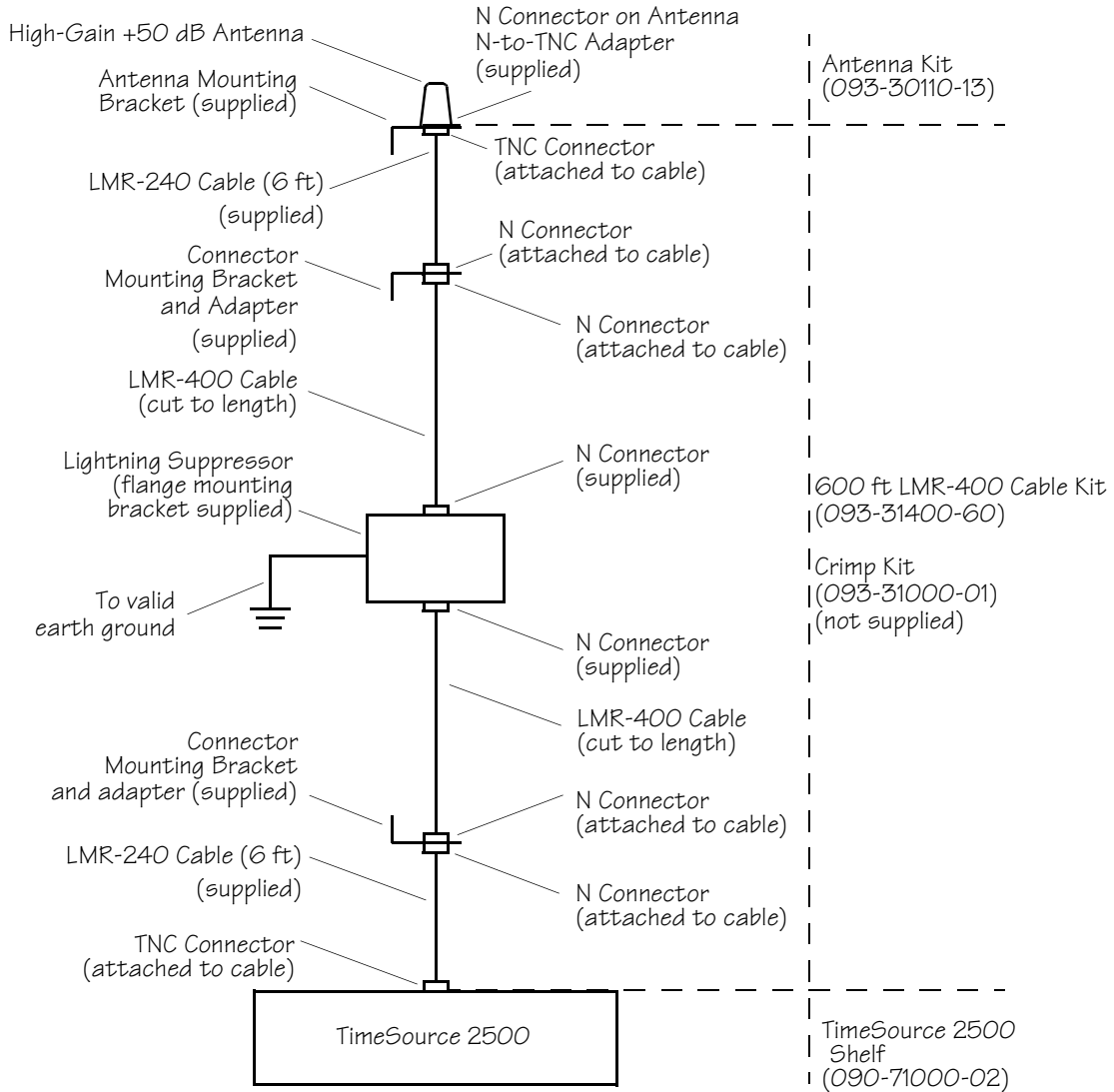
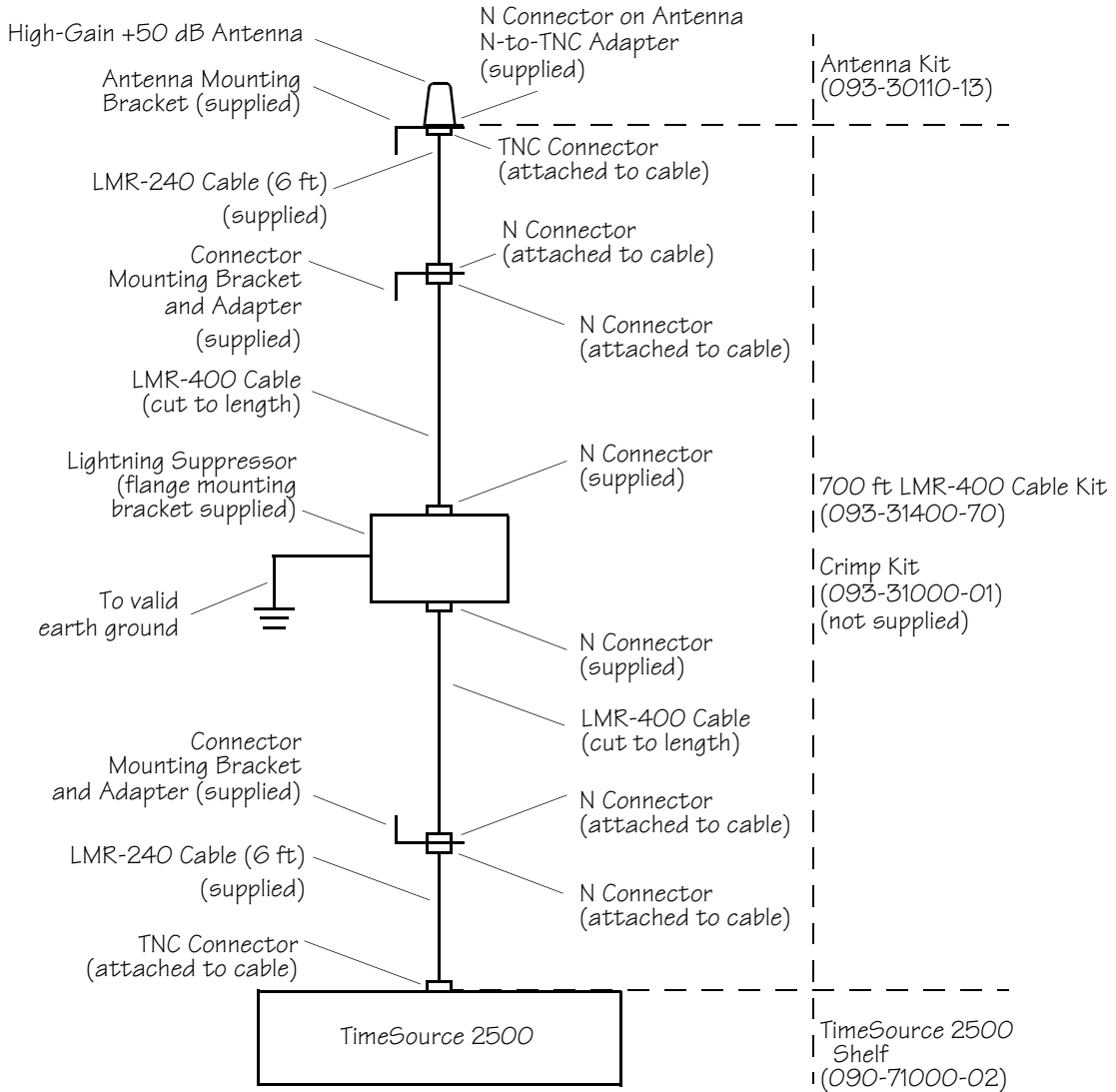
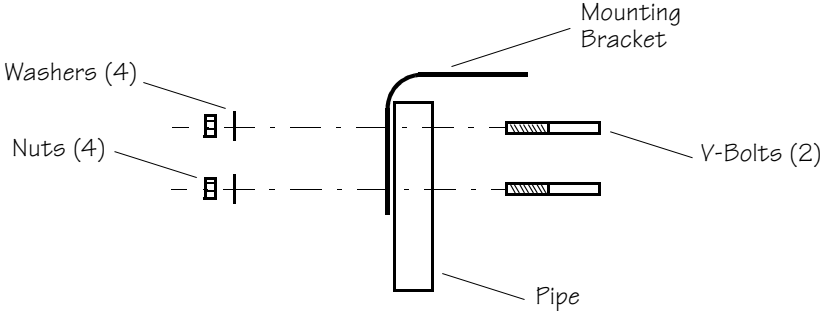
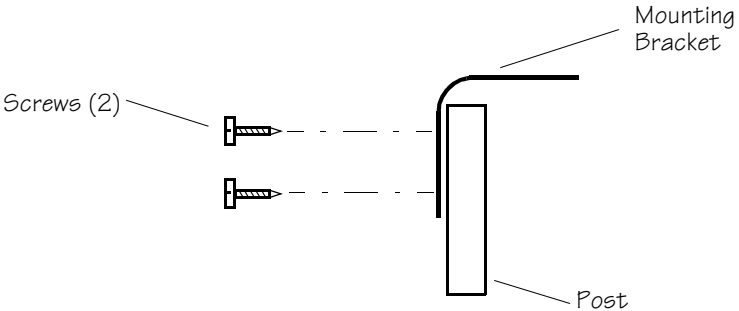

Figure 22. +50 dB Antenna-to-Shelf Cabling with LMR-240 and -400 Cable (400–700 Feet)



Procedure B. Antenna Installation

Step	Action
1	<p data-bbox="207 321 1136 350">Attach the antenna mounting bracket to a pipe (1 in. diameter) or a wood post.</p> <p data-bbox="207 380 1192 493">a. If mounting the bracket to a pipe, slide the two V-bolts over the pipe, through the mounting bracket slots; then secure the provided four washers and four nuts over the V-bolts, against the mounting bracket. Leave the V-bolts loose enough to allow for final adjustments, as shown below.</p> <div data-bbox="268 522 1094 831"><p>The diagram illustrates the assembly of the mounting bracket on a pipe. A vertical pipe is shown with a horizontal mounting bracket attached to its top. Two V-bolts are inserted through the pipe and the bracket's slots. On the left side of the bracket, four washers and four nuts are stacked over the V-bolts to secure them. Labels include: Washers (4), Nuts (4), Mounting Bracket, V-Bolts (2), and Pipe.</p></div> <p data-bbox="207 915 1192 1000">b. If mounting the bracket to a wood post, use the provided two self-tapping screws in two diagonally positioned mounting bracket slots and attach to the post, as shown below.</p> <div data-bbox="291 1068 1033 1377"><p>The diagram illustrates the assembly of the mounting bracket on a wood post. A vertical post is shown with a horizontal mounting bracket attached to its top. Two self-tapping screws are inserted through the post and the bracket's slots. Labels include: Screws (2), Mounting Bracket, and Post.</p></div>

Procedure B. Antenna Installation (cont'd)

Step	Action
2	<p data-bbox="251 300 1232 365">Slide the antenna bolts through the holes in the mounting bracket, then attach the antenna to the bracket, using the provided nuts and lockwashers, as shown below.</p> <p data-bbox="251 381 1232 446">For high-gain antennas only, connect the N-to-TNC adapter to the N connector on the antenna.</p> <div data-bbox="434 462 1050 868"><p data-bbox="434 479 616 535">Antenna ($\pm 5^\circ$ of vertical)</p><p data-bbox="840 649 1050 682">Antenna Bolts (3)</p><p data-bbox="840 730 1050 763">Lockwashers (3)</p><p data-bbox="840 828 951 860">Nuts (3)</p><p data-bbox="461 730 560 779">Mounting Bracket</p></div> <p data-bbox="616 893 868 925">A. Standard Antenna</p> <div data-bbox="420 1031 1050 1372"><p data-bbox="420 1039 602 1096">Antenna ($\pm 5^\circ$ of vertical)</p><p data-bbox="840 1161 1050 1193">Antenna Bolts (4)</p><p data-bbox="840 1242 1050 1274">Lockwashers (4)</p><p data-bbox="840 1331 951 1364">Nuts (4)</p><p data-bbox="448 1218 546 1266">Mounting Bracket</p></div> <p data-bbox="616 1396 868 1429">B. High-Gain Antenna</p>

Procedure B. Antenna Installation (cont'd)

Step	Action
3	Using a plumb line or bubble level, ensure the antenna is within 5° of vertical (perpendicular to the horizon), and tighten the mounting bracket bolts.
4	If the antenna-to-shelf cable route is 100 ft maximum, ignore Steps 5 through 8 and skip to Step 9. If the antenna-to-shelf cable route exceeds 100 ft, continue with Step 5.
5	<p>Within 6 ft of the antenna, attach the connector mounting bracket to a pipe (1 in. diameter) or a wood post.</p> <p>a. If mounting the bracket to a pipe, slide the two V-bolts over the pipe, through the mounting bracket slots; then secure the provided four washers and four nuts over the V-bolts, against the mounting bracket. Leave the V-bolts loose enough to allow for final adjustments, as shown in Step 1a.</p> <p>b. If mounting the bracket to a wood post, use the provided two self-tapping screws in two diagonally positioned mounting bracket slots and attach to the post, as shown in Step 1b.</p>
6	<p>Slide the connector mounting plate through the holes in the connector mounting bracket, then attach the plate to the bracket, using the provided three nuts and three lockwashers, as shown below.</p>

Procedure B. Antenna Installation (cont'd)

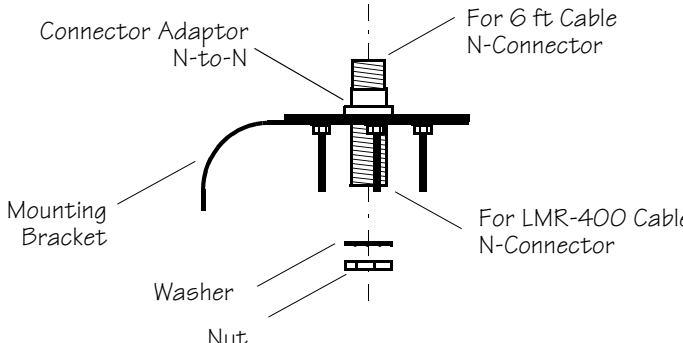
Step	Action
7	<p>Attach the connector adaptor to the connector mounting plate and bracket assembly, using the provided nut and washer, as shown below.</p>  <p>The diagram illustrates the assembly of a connector adaptor to a mounting bracket. A mounting bracket is shown with a curved cable attached. A connector adaptor (N-to-N) is being attached to the bracket. The adaptor has two N-connector ports. One port is labeled 'For 6 ft Cable N-Connector' and the other is labeled 'For LMR-400 Cable N-Connector'. A washer and nut are shown being used to secure the adaptor to the bracket.</p>
8	<p>Connect the 6 ft cable TNC connector to the antenna TNC connector, and connect the cable N-connector to the N-connector in the connector adaptor, as shown in Step 7.</p> <p><i>Note:</i> The cable route should be as direct as possible. Avoid sharp turns and unnecessary turns.</p>

Procedure B. Antenna Installation (cont'd)

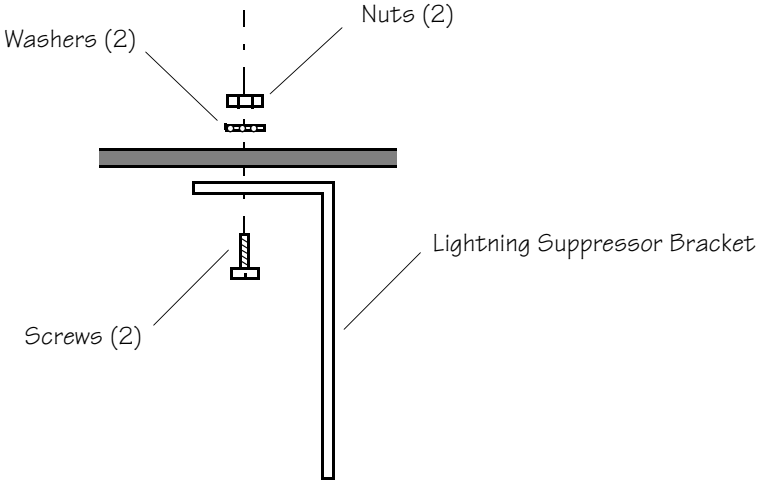
Step	Action
9	<p>Attach the lightning suppressor bracket, as shown below.</p> <p><i>Caution:</i> If the lightning suppressor is outside the building, Symmetricom recommends the suppressor be inside a weatherproof enclosure, otherwise, damage to the lightning suppressor may result.</p> <p><i>Note:</i> The lightning suppressor should be mounted such that the antenna end is pointed toward the entrance of the antenna cable into the building, and the shelf end is pointed toward the shelf.</p>  <p>The diagram illustrates the assembly of a lightning suppressor bracket. A horizontal shelf is shown. A lightning suppressor bracket is mounted to the underside of the shelf. The bracket consists of a vertical arm and a horizontal flange. A bolt passes through the shelf, the flange, and a nut is attached to the bottom. Two washers are placed between the shelf and the flange. Two screws are used to secure the bracket's vertical arm to the shelf. Labels include: Washers (2), Nuts (2), Screws (2), and Lightning Suppressor Bracket.</p>

Procedure B. Antenna Installation (cont'd)

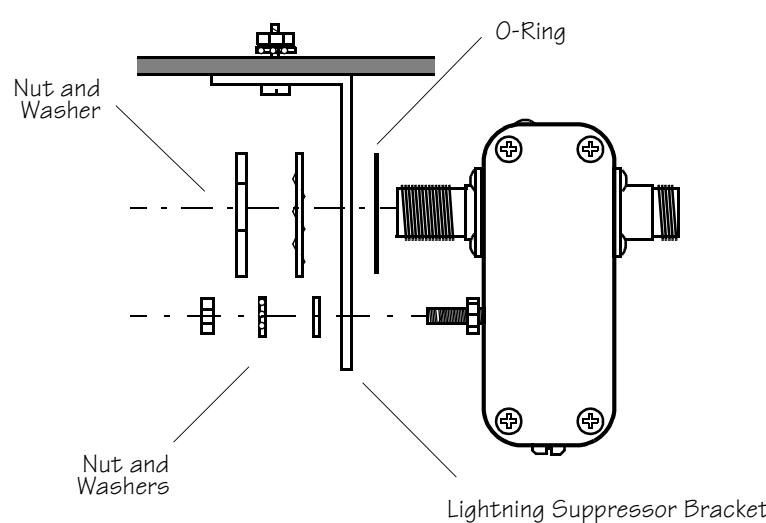
Step	Action
10	<p>Attach the lightning suppressor (PolyPhaser Corp. coaxial gas-discharge tube suppressor p/n IS-MR50LNZ+15 or equivalent) to the bracket, using the provided O-ring, nuts, and washers, as shown below.</p>  <p>The diagram illustrates the assembly of a lightning suppressor bracket. A horizontal plate is mounted on a vertical post. A lightning suppressor bracket is attached to the post. An O-ring is placed between the horizontal plate and the bracket. Nuts and washers are used to secure the assembly.</p> <p>Labels in the diagram include: Nut and Washer, O-Ring, Nut and Washers, and Lightning Suppressor Bracket.</p>

3

Procedure B. Antenna Installation (cont'd)

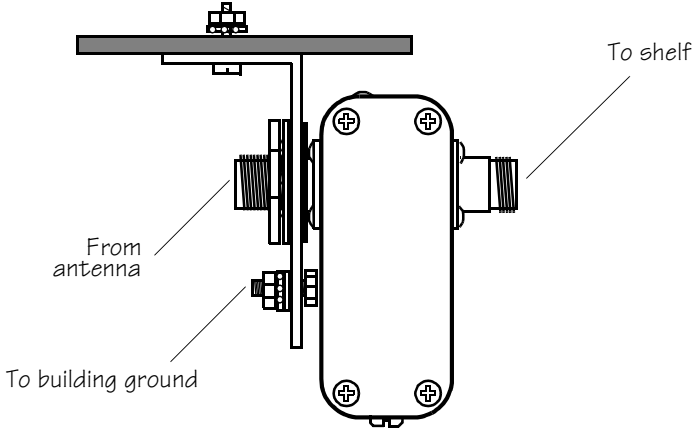
Step	Action
11	<p data-bbox="207 298 1167 358">Install the lightning suppressor; as shown below, following local company installation practices.</p>  <p data-bbox="207 915 1191 984"><i>Note:</i> Ensure that the grounding wire is routed as short and straight as possible. Do not route grounding wire through cable ducts.</p>

Procedure B. Antenna Installation (cont'd)

Step	Action
12	Obtain a ground cable (4 AWG if greater than 6 ft to a valid earth ground, otherwise 6 AWG), and crimp a lug on its end.
13	Route the ground cable to the valid earth ground, and connect, per local company practices.
14	Install 1 in. nonmetallic conduit from the antenna to the lightning suppressor, and from the lightning suppressor to the cable entrance into the building.
15	For cable kit 093-31240-10, skip to Step 18. For cable kits 093-31241-10, 093-31240-20, and 093-31240-35, continue to Step 16. For cable kits 093-31400-15, 093-31400-20, 093-31400-40, 093-31400-60, and 093-31400-70, skip to Step 20.
16	Measure and cut a length of LMR-240 cable to make one cable to connect between the antenna and lightning suppressor, and one cable to connect between the lightning suppressor and shelf, according to the planned cable route measurements. Allow sufficient slack in the cable to secure it per local company practice.



Procedure B. Antenna Installation (cont'd)

Step	Action
17	<p data-bbox="207 298 1159 357">Use the user-supplied LMR-240 cable stripper and crimp tool to attach one of the provided N-connectors to one end of the cut cable, as shown below.</p> <div data-bbox="235 402 1141 820"><p>The diagram illustrates the assembly of an N-connector to an LMR-240 cable. On the left, the N-connector is shown with a 'Boot' and a 'Center Conductor'. On the right, the LMR-240 cable is shown with a 'Dielectric, Foil, and Braid' layer, a 'Ferrule', a 'Jacket', and 'Heat-shrink Tubing'. The diagram shows the cable being inserted into the N-connector. Two dimensions are provided: 0.2 in. ±0.02 in. for the dielectric, foil, and braid layer, and 0.41 in. ±0.01 in. for the ferrule.</p></div> <ol data-bbox="207 852 1202 1144" style="list-style-type: none">Place the ferrule and heat-shrink tubing on the cable (do not heat-shrink yet).Unflatten the cut cable into a round form and ensure the center conductor is centered within the cable diameter.Use the cable stripper to strip the cable, as shown above. Then, pull away the jacket.Dress the dielectric, foil, and braid to ensure they are not contacting the center conductor. <p data-bbox="207 1177 1202 1242">Warning: If threads from the dielectric, foil, or braid contact the center conductor, the conductor may not function.</p>

Procedure B. Antenna Installation (cont'd)

Step	Action
17 cont'd	<ul style="list-style-type: none">e. Insert the cable into the N-connector while ensuring the braid flares over the boot, and push the cable into the connector, until the dielectric and foil bottom internally.f. Place the ferrule against the N-connector.g. Place the heat-shrink tubing against the N-connector, then heat-shrink.h. Repeat Steps a through g for the end of the other cable.
18	<p>Route the cable between the antenna and lightning suppressor through the conduit, and connect the cable.</p> <p><i>Note:</i> The cable route should be as direct as possible. Avoid sharp turns and unnecessary turns.</p>
19	<p>Route the cable from the lightning suppressor through the conduit and into the building to the shelf TNC connector, and connect the cable; then skip to Step 29.</p> <p><i>Note:</i> The cable route should be as direct as possible. Avoid sharp turns and unnecessary turns.</p>
20	<p>Measure and cut a length of LMR-400 cable to connect between the connector bracket and the lightning suppressor, according to the planned cable route measurements. Allow sufficient slack in the cable to secure it per local company practice.</p>



Procedure B. Antenna Installation (cont'd)

Step	Action
21	<p data-bbox="207 298 1187 357">Use the crimp kit to attach one of the provided N-connectors to each end of the cut cable, as shown below.</p> <div data-bbox="235 396 1142 828"><p>The diagram illustrates the assembly of an N-connector onto an LMR-400 cable. On the left is an N-connector with a central pin. On the right is an LMR-400 cable with a central conductor, a braided shield, a dielectric and foil layer, a jacket, and heat-shrink tubing. A ferrule is shown crimped onto the central conductor, and the heat-shrink tubing is being slid over the ferrule and the braided shield.</p></div> <ol data-bbox="207 902 1192 1396" style="list-style-type: none">Place the ferrule and heat-shrink tubing on the cable (do not heat-shrink yet).Unflatten the cut cable into a round form and ensure the center conductor is centered within the cable diameter (refer to the instructions supplied with the provided cable stripper for details).Use the cable stripper to strip the cable: rotate “side 1” of the stripper over the cable clockwise, with forward pressure, until the tool turns easily, to expose the center conductor. Then, rotate “side 2” over the cable clockwise, with minimum forward pressure, until the tool rotates freely, to pull away the jacket. (Sides are indicated on the cable stripper; refer to the instructions supplied with the cable stripper for details).Use an Exacto knife to cut away any dielectric or foil from the center conductor.Use the provided deburring tool to remove the edge from the center conductor (attach the deburring cutter to the handle, then deburr).

Procedure B. Antenna Installation (cont'd)

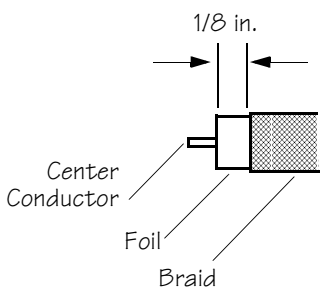
Step	Action
21 cont'd	<p data-bbox="251 300 1239 389">f. Use side cutters to trim the braid approximately 1/8 in. back from the foil (see below), then dress the insulation to ensure any part of the dielectric, foil, or braid is not contacting the center conductor.</p> <p data-bbox="251 414 1239 495">Warning: If threads from the dielectric, foil, or braid contact the center conductor, the conductor may not function.</p> <div data-bbox="616 527 937 820"><p>The diagram illustrates a cross-section of a cable. It features a central 'Center Conductor' surrounded by a 'Foil' layer, which is in turn surrounded by a 'Braid' layer. A dimension line with arrows at both ends is positioned above the foil and braid layers, indicating a distance of 1/8 in. between the foil and the braid. This gap is intended to prevent the braid from touching the center conductor.</p></div> <p data-bbox="251 917 1239 1209">g. Slide the N-connector between the cable braid and foil. h. Place the ferrule against the N-connector. i. Install a die (provided) in the provided crimp tool, then crimp the ferrule to the connector (refer to the instructions supplied with the crimp tool for details). j. Place the heat-shrink tubing against the N-connector; then heat-shrink. k. Repeat Steps a through j for the other end of the cable.</p>

.....

Procedure B. Antenna Installation (cont'd)

Step	Action
22	<p>Route the cable between the connector bracket and the lightning suppressor through the conduit, and connect the cable.</p> <p><i>Note:</i> The cable route should be as direct as possible. Avoid sharp turns and unnecessary turns.</p>
23	<p>For a wall-mounted shelf, install the N-to-N adapter bracket to a wall within 6 ft of the shelf, using user-supplied bolts or screws.</p> <p>For a rack-mounted shelf, the N-to-N adapter may be mounted to the rack instead of the wall.</p>
24	Install the N-to-N connector adapter in the adapter bracket installed in Step 23.
25	Measure and cut a length of LMR-400 cable to connect between the connector bracket and the lightning suppressor, according to the planned cable route measurements. Allow sufficient slack in the cable to secure it per local company practice.
26	Use the crimp kit to attach one of the provided N-connectors to each end of the cut cable (as shown in Step 21). (For details, refer to Steps 21a through 21k.)
27	<p>Route the cable from the lightning suppressor through the conduit and into the building to the connector bracket, and connect the cable.</p> <p><i>Note:</i> The cable route should be as direct as possible. Avoid sharp turns and unnecessary turns.</p>
28	Connect the 6 ft cable TNC connector to the shelf TNC connector; and connect the cable N-connector to the N-connector in the connector adaptor.
29	Install fire-stopping material in all holes opened in the roof and/or walls during this procedure.
30	Check all connections for tightness to prevent arcing and intermittent operation.
31	Spray all exposed connectors with an electrically conductive antioxidant compound (e.g., Kopr-Shield).

Shelf

Rack Mounting

The mounting ears, as shown in Figure 23, can be positioned for flush or 5 inch offset mounting, in either a 19 inch rack (Figure 23A) or a 23 inch rack (Figure 23B). To mount the shelf, follow Procedure C.

Figure 23. Rack Mounting Options

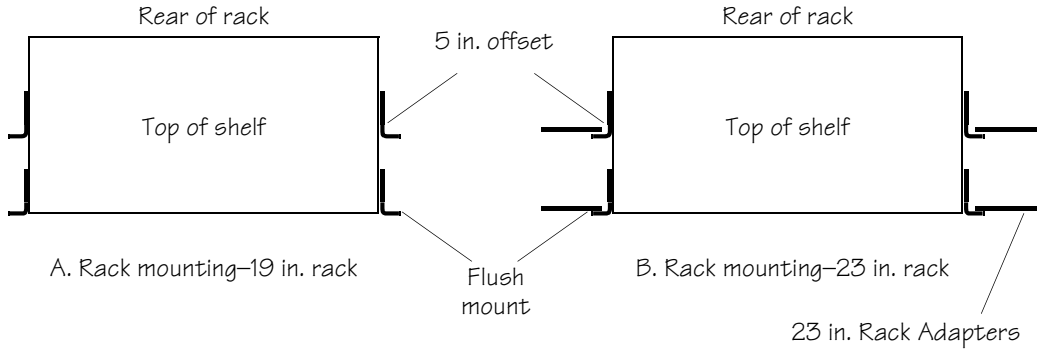

Procedure C. Rack Mounting

Step	Action
1	Position the mounting ears on the shelf for flush mounting or 5 in. offset mounting, as required. If mounting in a 23 in. rack, attach the 23 in. rack adapters.
2	Mount the shelf in the rack.
3	If a wire-wrap panel is not used, this procedure is completed. If using a wire-wrap panel, mount the panel (Figure 24) to the rack just below the TimeSource 2500.
4	Connect the cables (included in the wire-wrap panel kit) between the front panel connectors of the TimeSource 2500 and the connectors on the inside of the wire-wrap panel, as listed in Table C.

Figure 24. Rack Mounting with Wire-Wrap Panel

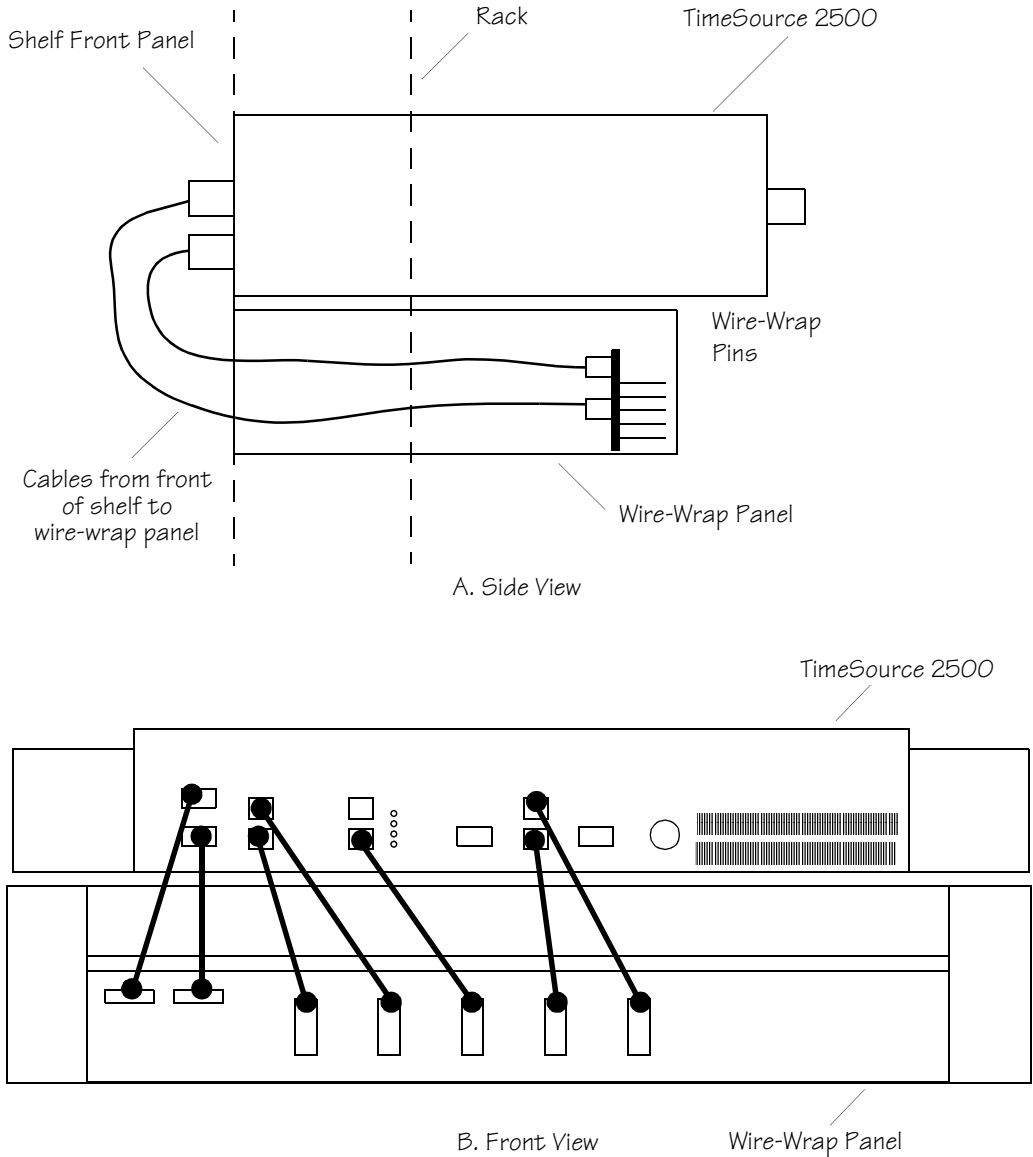

3

Table C. Cable Connections

TimeSource 2500	Wire-Wrap Panel	Cable Type
Power A	P1 PWR-A	DB9 – 3-pin Molex
Power B	P2 PWR-B	DB9 – 3-pin Molex
Output Span A	J3 OUTPUT A	RJ-45 – 5-pin Molex
Output Span B	J4 OUTPUT B	RJ-45 – 5-pin Molex
Alarms	J5 ALARM	RJ-45 – 5-pin Molex
Input Span A	J1 INPUT A	RJ-45 – 5-pin Molex
Input Span B	J2 INPUT B	RJ-45 – 5-pin Molex

Wall Mounting

The TimeSource 2500 can be attached to a wall or other surface. Attach the proper mounting ears, included with the TimeSource 2500, as shown in Figure 25, then use appropriate screws (not included) to attach to the chosen surface.

Figure 25. Wall Mounting

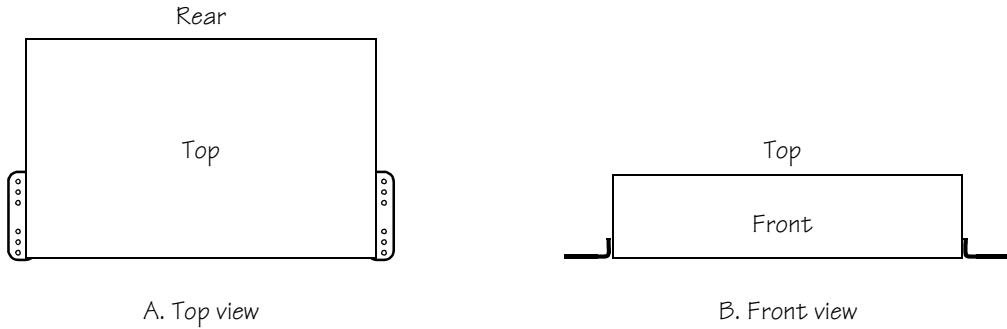

Cabling

The connection from the GPS antenna is on the rear of the TimeSource 2500 Shelf. All other connections are made on the front of the shelf. When installing the TimeSource 2500 in a rack with a wire-wrap panel, connections are made at the rear of the wire-wrap panel. Figure 26 shows the locations of the connectors on the front of the shelf, and Figure 27 shows the locations of the connectors on the rear of the wire-wrap panel.

Figure 26. Shelf Front Panel Connectors

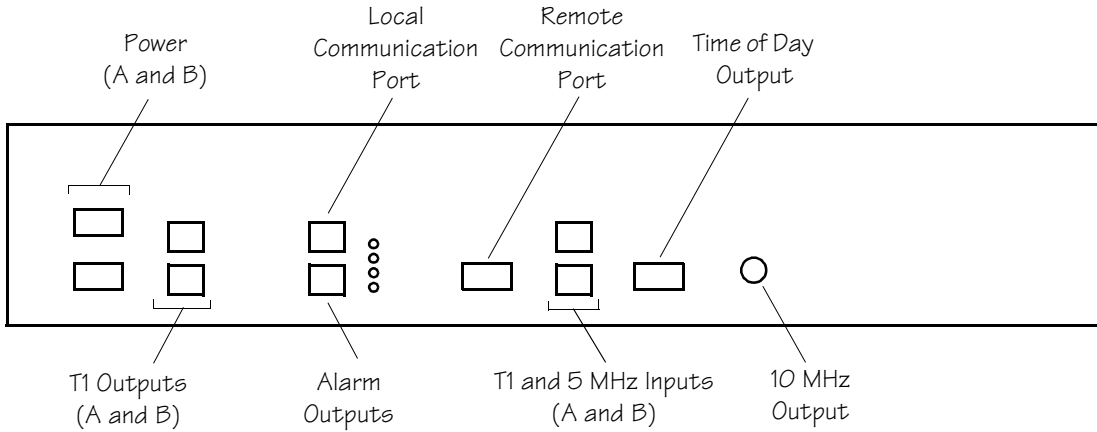
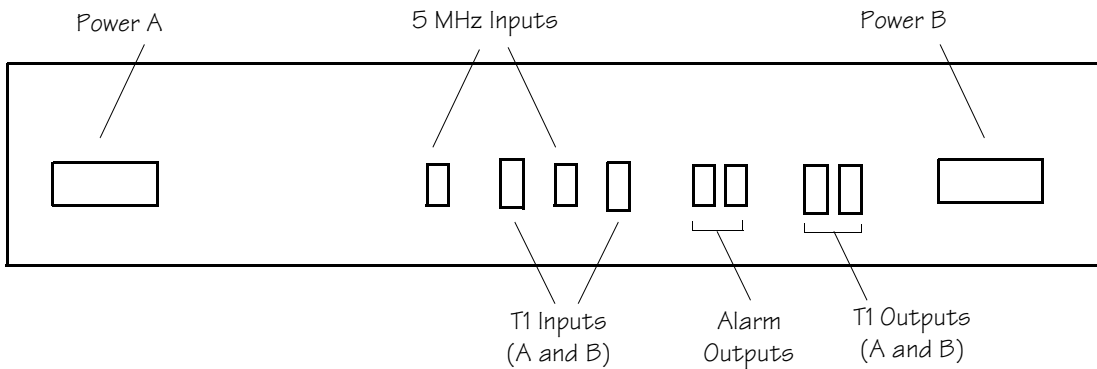

Figure 27. Wire-Wrap Rear Panel Connectors



Frame Ground

Shelf Front Panel

Frame ground enters through the Power A and Power B connectors. These are nine-pin male DB9 connectors. Refer to Figure 26 for the location of the connectors. The pinouts in the connectors are listed in Table D.

Ensure the frame ground wires are long enough to go from the shelf front panel to the frame ground connection. Solder the frame ground wires to pin 6 of customer-supplied female DB9 connectors.

Table D. Front Panel Frame Ground and Power Connector Pinouts

Pin	Signal
1	-48 V dc
2	Battery return
6	Frame ground

Note: Pins not listed are reserved for future use.

Make the ground connection, following one of the methods described below, depending on whether a ground rod is installed:

[With ground rod](#)

Solder the frame ground connection to the 6 AWG frame ground rod run vertically on each side of the rack. Use one of the following methods for connecting the wire from pin 6 of the DB9 connector to the 6 AWG rod.

- Crimp an appropriate-size spade lug to the ground wire from the DB9 connector, bend the lug around the 6 AWG rod, and solder.
- Strip enough insulation from the ground wire from the DB9 connector to permit three complete turns around the 6 AWG rod, and solder.

Note: When soldering, use a 25 watt soldering iron to ensure the 6 AWG rod is heated sufficiently, to prevent a cold solder connection.

[Without ground rod](#)

Crimp an appropriate-sized spade lug to the wire from pin 6 of the DB9 connector, and secure the lug to a screw hole on the rack. Remove the paint, and sand the area around the screw hole, to ensure proper conductivity.

Wire-Wrap Rear Panel

Frame ground enters through the PWR-A and PWR-B terminal blocks. Refer to Figure 27 for the location of the terminal blocks. The terminals in the terminal blocks are listed in Table E.

Ensure the frame ground wires are long enough to go from the wire-wrap panel to the frame ground connection. Connect the frame ground wires to terminal F of the terminal blocks, using appropriate sized spade lugs.

Table E. Wire-Wrap Panel Frame Ground and Power Terminal Block Pinouts

Terminal	Signal
-	-48 V dc
+	Battery return
F	Frame ground

Make the ground connection, following one of the methods described below, depending on whether a ground rod is installed:

[With ground rod](#)

Solder the frame ground connection to the 6 AWG frame ground rod run vertically on each side of the rack. Use one of the following methods for connecting the wire from terminal F of the terminal block to the 6 AWG rod.

- Crimp an appropriate-size spade lug to the ground wire from the terminal block, bend the lug around the 6 AWG rod, and solder.
- Strip enough insulation from the ground wire from the terminal block to permit three complete turns around the 6 AWG rod, and solder.

Note: When soldering, use a 25 watt soldering iron to ensure the 6 AWG rod is heated sufficiently to prevent a cold solder connection.

[Without ground rod](#)

Crimp an appropriate-sized spade lug to the wire from terminal F of the terminal block, and secure the lug to a screw hole on the rack. Remove the paint, and sand the area around the screw hole, to ensure proper conductivity.

Power

Caution: Ensure the fuses in the fuse panel which will be used to power the TimeSource 2500 Shelf are removed before connecting power.

Note: Input power is reverse polarity protected; there are no user replaceable fuses.

Shelf Front Panel

The -48 volt dc battery enters through the Power A and Power B connectors. These are nine-pin male DB9 connectors. Refer to Figure 26 for the location of the connectors. The pinouts in the connectors are listed in Table D.

If two office battery supplies (battery A and battery B) are not available, connect the single office battery to the Power A connector on the shelf front panel. This is not a recommended arrangement.

Ensure the power wires are long enough to go from the shelf front panel to the office battery source connection. Solder the power wires to customer-supplied female DB9 connectors, following the pinouts listed in Table D, then connect to the Power A and Power B connectors on the front panel.

Connect the power leads from pins 1 and 2 to the office battery source, but do not apply the office battery to the TimeSource 2500 at this time.

Wire-Wrap Rear Panel

The -48 volt dc battery enters through the PWR-A and PWR-B terminal blocks. Refer to Figure 27 for the location of the terminal blocks. The terminals in the terminal blocks are listed in Table E.

If two office battery supplies (battery A and battery B) are not available, connect the single office battery to the PWR-A terminal block on the rear of the wire-wrap panel. This is not a recommended arrangement.

To connect power, ensure the power wires are long enough to go from the wire-wrap panel to the office battery source connection. Connect the power wires to the terminals listed in Table E, using appropriate sized spade lugs.

Connect the leads from the - and + terminals to the office battery source, but do not apply the office battery to the TimeSource 2500 at this time.

T1 Outputs

Shelf Front Panel

Connect the T1 outputs to the two RJ45 connectors labeled Output Span A and Span B. Figure 26 shows the location of the connectors. The pinouts of each of the connectors (Output Span A and Span B) are listed in Table F.

Note: The shield is normally grounded only at the signal source. Grounding the shield at both ends is not recommended.

Table F. Front Panel T1 Output Connector Pinouts

Pin	Signal Name
4	Ring
5	Tip
7	Frame ground
8	Frame ground

Note: Pins not listed are reserved for future use. Use category 5 EIA/TIA 568 A or B compliant cable.

Wire-Wrap Rear Panel

Connect the T1 outputs to the two wire-wrap connectors labeled OUTPUT DS1-A and DS1-B. Figure 27 shows the location of the connectors. The pinouts of each of the connectors (OUTPUT DS1-A and DS1-B) are listed in Table G.

Table G. Wire-Wrap Panel T1 Output Connector Pinouts

Pin	Signal Name
R	Ring
T	Tip
S	Frame ground

Local Communication Port

Make a direct connection to the TimeSource 2500 communication port at the RJ45 connector labeled Craft. Figure 26 shows the location of the connector. The pinouts of the connector are listed in Table H.

Note: TL1 messages are available only via the Craft port.

Table H. Local Communication Port Connector Pinouts

Pin	Signal	Abbreviation	Direction
2	Transmit data	TXD	From TimeSource 2500
3	Receive data	RXD	To TimeSource 2500
4	Data set ready	DSR	To TimeSource 2500
5	Signal ground	GND	—
6	Data terminal ready	DTR	From TimeSource 2500
7	Frame	—	—
8	Frame	—	—

Note: Pins not listed are reserved for future use.

Alarm Outputs

Shelf Front Panel

The RJ45 connector labeled Alarms provides dry-contact relay closure points. The relay contacts are normally open, and close when reporting an alarm. Figure 26 shows the location of the connector. Connect between the Major pins for a major alarm, and between the Minor pins for a minor alarm. The pinouts of the connector are listed in Table I.

Table I. Alarm Output Connector Pinouts

Pin	Alarm	Contacts During No Alarm	Contacts During Alarm	Contacts During Power Off
1	Major	Open	Closed	Closed
5				
2	Minor	Open	Closed	Open
4				

Note: Pins not listed are reserved for future use.

Wire-Wrap Rear Panel

The two wire-wrap connectors labeled ALARM MAJ and MIN provide dry-contact relay closure points. Figure 27 shows the location of the connectors. Connect between the MAJ connector + and – pins for a major alarm, and between the MIN connector + and – pins for a minor alarm.

Remote Communication Port

Make connections to the data terminal equipment (DTE) port at the connector labeled Remote RS-232. This is a nine-pin female DB9 connector. Figure 26 shows the location of the connector. The pinouts of the connector are listed in Table J.

Table J. Remote Communication Port Connector Pinouts

Pin	Signal	Abbreviation	Direction
1	Data carrier detect	DCD	To TimeSource 2500
2	Receive data	RXD	To TimeSource 2500
3	Transmit data	TXD	From TimeSource 2500
4	Data terminal ready	DTR	From TimeSource 2500
5	Return/signal ground	RTN	—
6	Data set ready	DSR	To TimeSource 2500
7	Request to send	RTS	From TimeSource 2500
8	Clear to send	CTS	To TimeSource 2500

Note: Pins not listed are reserved for future use.

T1 and 5 MHz Inputs

Shelf Front Panel

Connect the optional T1 inputs and the optional 5 MHz inputs to the two RJ45 connectors labeled Input Span A and Span B. Figure 26 shows the location of the connectors. The pinouts of each of the connectors are listed in Table K.

Note: The shield is normally grounded only at the signal source. Grounding the shield at both ends is not recommended.

Table K. Front Panel T1 and 5 MHz Input Connector Pinouts

Pin	Signal
1	Ring
2	Tip
3	5 MHz (positive)
6	5 MHz (negative)
7	Frame ground
8	Frame ground

Note: Pins not listed are reserved for future use.

Wire-Wrap Panel

Connect the optional T1 inputs to the two wire-wrap connectors labeled INPUT DS1-A and DS1-B. Figure 27 shows the location of the connectors. The pinouts of each of the connectors are listed in Table L.

Note: The shield is normally grounded only at the signal source. Grounding the shield at both ends is not recommended.

Table L. Rear Wire-Wrap Panel T1 Input Connector Pinouts

Pin	Signal
R	Ring
T	Tip
S	Frame ground

Connect the optional 5 MHz inputs to the two wire-wrap connectors labeled INPUT 5M A and 5M B. Figure 27 shows the location of the connectors. The pinouts of each of the connectors are listed in Table M.

Table M. Rear Wire-Wrap Panel 5 MHz Input Connector Pinouts

Pin	Signal
+	5 MHz (positive)
-	5 MHz (negative)

Time of Day Output

Connect the time of day (TOD) output to the connector labeled TOD RS-422. This is a nine-pin female DB9 connector. Figure 26 shows the location of the connector. The pinouts of the connector are listed in Table N.

Table N. TOD Output Connector Pinouts

Pin	Signal
1	1 pps output (positive)
3	Return for external 20 V NL
5	TXA output (positive)
6	1 pps output (negative)
7	External 20 V NL
9	TXA output (negative)

Note: Pins not listed are reserved for future use.

10 MHz Output

Connect a BNC connector from the connector labeled 10MHz Output to the equipment that will use the 10 MHz output signal. Refer to Figure 26 for the connector location.

GPS Antenna

Connect the cable from the GPS antenna to the TNC connector labeled GPS RF In. Refer to Figure 28 for the connector location.

Figure 28. Shelf Rear Panel Connection

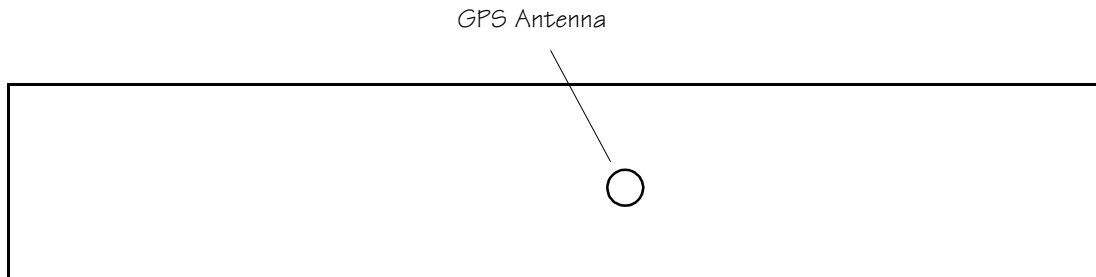

Power-Up

Use Procedure D to install BTMONitor at a site where the host computer is connected to the Craft connector of the TimeSource 2500 with a cable, and set up BTMONitor.

Procedure D. Power-Up

Step	Action
1	Locate a directory, or create a new directory, on your hard disk, to store the BTMONitor application.
2	Copy the files from the BTMONitor disk to the directory.
3	Create a Windows shortcut to BTMONitor, and place the shortcut on the Windows Desktop. One method to accomplish this is to open Windows Explorer in an unmaximized window with some of the Desktop visible around it. Then, navigate to the BTMONitor file and drag the file to the Desktop. Click OK if Windows asks to make a shortcut file.
4	Connect the supplied serial communications cable between the TimeSource 2500 Craft connector and a serial communications port on the computer.
5	Install fuses in the fuse panel that powers the TimeSource 2500. On the front panel, when the Minor Alarm lamp is yellow, and the Locked lamp is blinking green, continue.

Procedure D. Power-Up (cont'd)

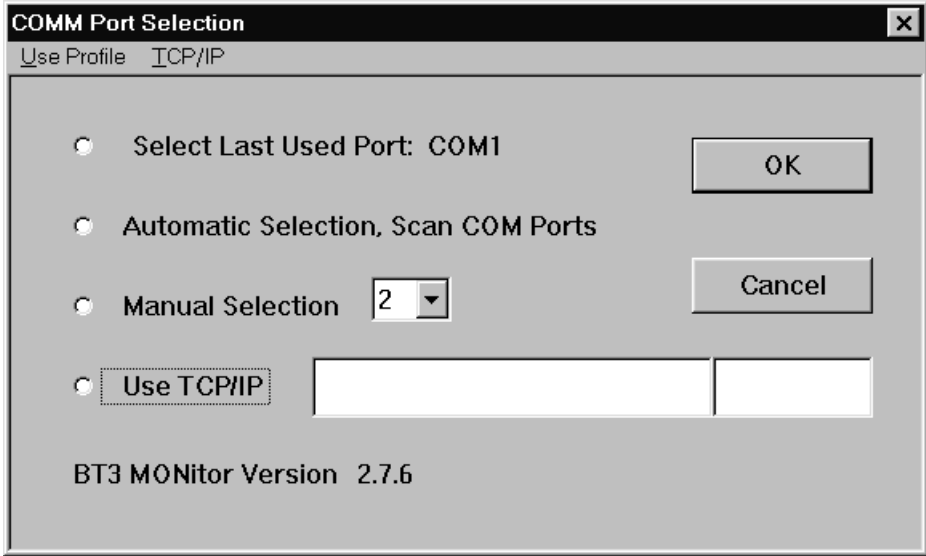
Step	Action
6	<p>Open the BTMONitor application. The COMM Port Selection screen appears.</p> 
7	<p>Choose a communications port by clicking one of the following:</p> <ul style="list-style-type: none">• Select Last Used Port: COMx:. This selection will use the named serial communications port, which BTMONitor identifies as the one used in the previous session, when the OK button is clicked.• Automatic Selection, Scan COM Ports. This selection will scan the serial communications ports on the host computer for the communications port connected to the TimeSource 2500 when the OK button is clicked.• Manual Selection: Allows the user to enter or choose the host computer communication port that is connected to the TimeSource 2500.

Procedure D. Power-Up (cont'd)

Step	Action
8	Click OK. Verify a User Login screen appears (shown below).

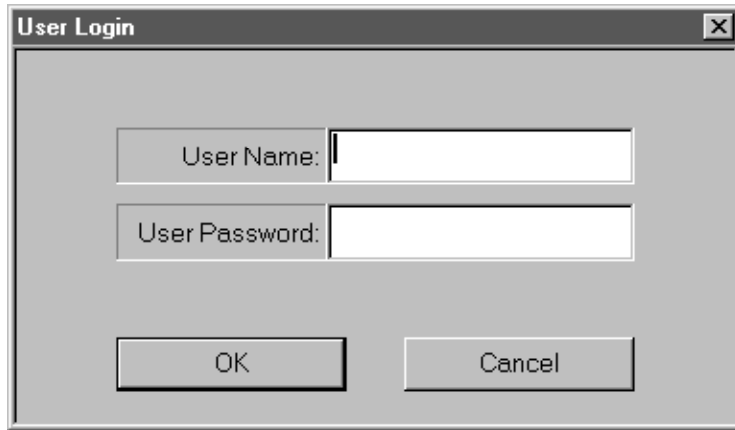

Note: If a dialog box appears stating, “Failed to Open COM Port” instead of the User Login screen, verify that the TimeSource 2500 is powered, and the serial communications are connected. Then click OK, and repeat Steps 7 and 8.

Procedure D. Power-Up (cont'd)

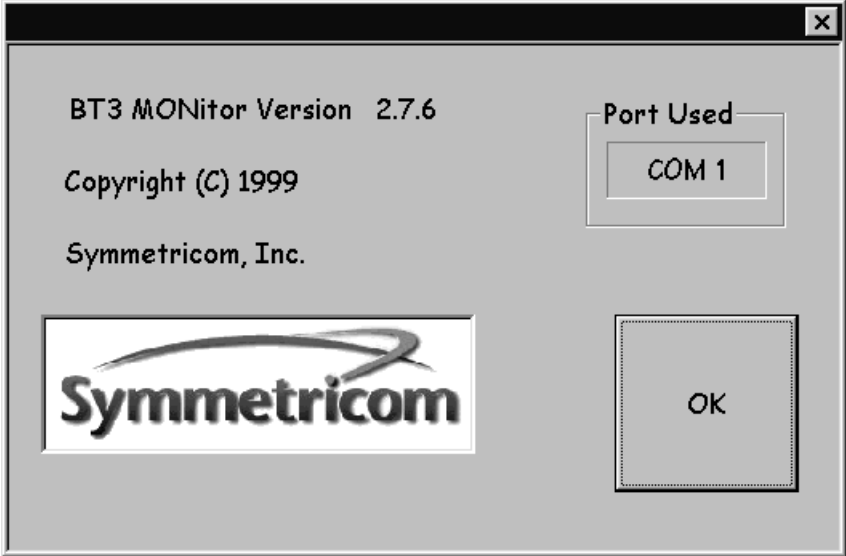
Step	Action
9	<p>Enter the user name and password for this installation, then click the OK button. A screen appears showing the version number, copyright date, and the serial port that communicates with the TimeSource 2500 (shown below).</p> <p><i>Notes:</i></p> <ol style="list-style-type: none">1. The user name, "default1", is set at the factory, and the password, "TS2500:", is set at the factory. Be sure to enter the entire password, including the colon.2. The user name and password are case-sensitive.3. If an incorrect user name and password are entered three consecutive times, the BTMONitor application exits and ends the attempted session. If this happens, re-open the application, and enter the correct user name and password. 

Procedure D. Power-Up (cont'd)

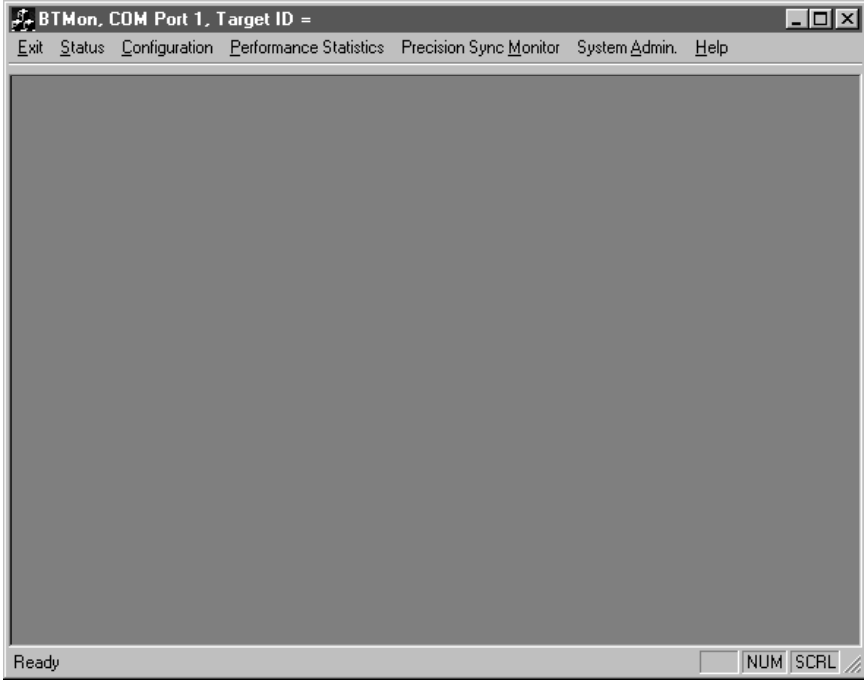
Step	Action
10	<p>Verify the correct version number and serial port, then click the OK button. The BTMONitor main screen appears (shown below).</p> 

Procedure D. Power-Up (cont'd)

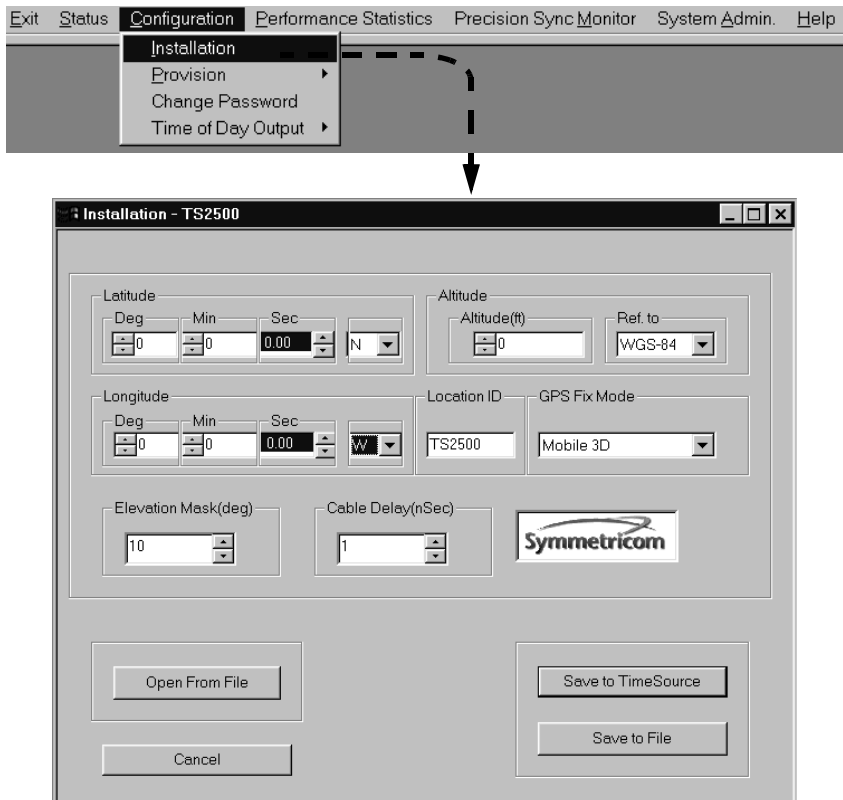
Step	Action
11	<p>Select Configuration from the main screen, then select Installation, as shown below.</p>  <p>The screenshot shows the main menu with 'Configuration' selected. The 'Installation' option is highlighted in the dropdown menu. An arrow points from the 'Installation' option to the 'Installation - TS2500' window. The window contains the following fields:</p> <ul style="list-style-type: none">Latitude: Deg (0), Min (0), Sec (0.00), NAltitude: Altitude(ft) (0), Ref. to (WGS-84)Longitude: Deg (0), Min (0), Sec (0.00), WLocation ID: TS2500GPS Fix Mode: Mobile 3DElevation Mask(deg): 10Cable Delay(nSec): 1Buttons: Open From File, Save to TimeSource, Save to File, Cancel <p>Notes:</p> <ol style="list-style-type: none">1. Factory settings are shown for Latitude, Altitude, Longitude, Location ID, GPS Fix Mode, Elevation Mask, and Cable Delay.2. Entering the latitude, altitude, and longitude manually is not recommended. The TimeSource 2500 will automatically find its position on the earth without latitude, altitude, and longitude entered.

.....

Procedure D. Power-Up (cont'd)

Step	Action
12	<p>In the Location ID area: Enter two to eight alphanumeric characters for the TimeSource 2500 identification. The identification name can be used to identify this particular TimeSource 2500 among multiple TimeSource 2500 Systems.</p> <p><i>Caution:</i> Use the factory-set name or entire a name. Do not leave this field blank.</p>
13	<p>Verify GPS Fix Mode is set to Mobile 3D.</p> <p><i>Caution:</i> If Mobile 3D mode is not selected, the system cannot automatically acquire latitude, longitude, and altitude data.</p>
14	<p>In the Elevation Mask area: Enter the elevation mask. Type, or use the up and down arrows on the right side of the data entry box. The receiver does not seek satellites from the horizon to this number of degrees above the horizon. The factory default setting is 10.</p>

Procedure D. Power-Up (cont'd)

Step	Action																										
15	<p data-bbox="253 298 1236 386">In the Cable Delay area: Enter the number of ns corresponding to your cable kit part number from the list below. Type or use the up and down arrows on the right side of the data entry box.</p> <table border="1" data-bbox="439 427 1058 1049"> <thead> <tr> <th data-bbox="439 427 704 532">Cable Kit Part No.</th> <th data-bbox="704 427 890 532">Total Cable Length (ft)</th> <th data-bbox="890 427 1058 532">Delay (ns)</th> </tr> </thead> <tbody> <tr> <td data-bbox="439 532 704 589">093-31240-10</td> <td data-bbox="704 532 890 589" rowspan="2">100</td> <td data-bbox="890 532 1058 589" rowspan="2">158</td> </tr> <tr> <td data-bbox="439 589 704 646">093-31241-10</td> </tr> <tr> <td data-bbox="439 646 704 703">093-31400-15</td> <td data-bbox="704 646 890 703">150</td> <td data-bbox="890 646 1058 703">242</td> </tr> <tr> <td data-bbox="439 703 704 760">093-31400-20</td> <td data-bbox="704 703 890 760" rowspan="2">200</td> <td data-bbox="890 703 1058 760" rowspan="2">320</td> </tr> <tr> <td data-bbox="439 760 704 816">093-31240-20</td> </tr> <tr> <td data-bbox="439 816 704 873">093-31240-35</td> <td data-bbox="704 816 890 873">350</td> <td data-bbox="890 816 1058 873">553</td> </tr> <tr> <td data-bbox="439 873 704 930">093-31400-40</td> <td data-bbox="704 873 890 930">400</td> <td data-bbox="890 873 1058 930">640</td> </tr> <tr> <td data-bbox="439 930 704 987">093-31400-60</td> <td data-bbox="704 930 890 987">600</td> <td data-bbox="890 930 1058 987">960</td> </tr> <tr> <td data-bbox="439 987 704 1049">093-31400-70</td> <td data-bbox="704 987 890 1049">700</td> <td data-bbox="890 987 1058 1049">1120</td> </tr> </tbody> </table>	Cable Kit Part No.	Total Cable Length (ft)	Delay (ns)	093-31240-10	100	158	093-31241-10	093-31400-15	150	242	093-31400-20	200	320	093-31240-20	093-31240-35	350	553	093-31400-40	400	640	093-31400-60	600	960	093-31400-70	700	1120
Cable Kit Part No.	Total Cable Length (ft)	Delay (ns)																									
093-31240-10	100	158																									
093-31241-10																											
093-31400-15	150	242																									
093-31400-20	200	320																									
093-31240-20																											
093-31240-35	350	553																									
093-31400-40	400	640																									
093-31400-60	600	960																									
093-31400-70	700	1120																									

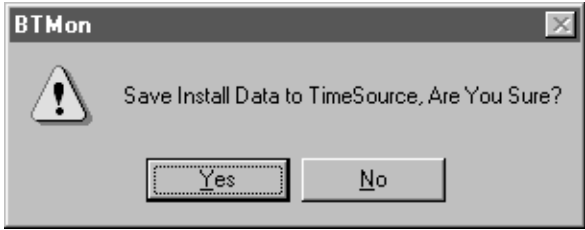
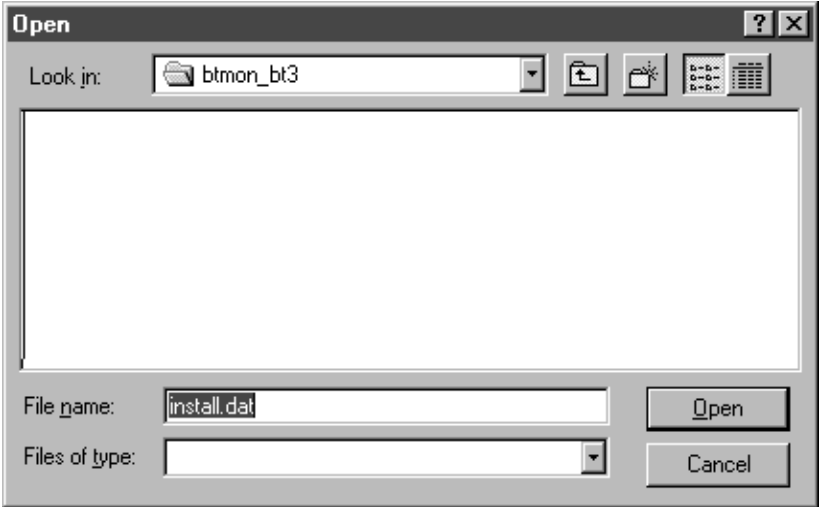

Procedure D. Power-Up (cont'd)

Step	Action
16	<p>When the parameters are set as desired, click the Save to TimeSource button to save the information on this screen to the TimeSource 2500. A dialog box appears to confirm the action (see below). Click Yes to save the parameters to the TimeSource 2500.</p> 
17	<p>Click the Save to File button to save the contents of the screen to a file on a disk using a standard Windows File Save dialog box (shown below).</p> <p><i>Note:</i> Saving the Installation screen information to a file may be useful for reinitializing the TimeSource 2500 if the unit loses critical memory or is taken out of service.</p> 

.....

Procedure D. Power-Up (cont'd)

Step	Action
18	Choose a folder in the file system of your computer; enter a unique filename, and click the Open button.
19	Wait until the TimeSource 2500 front panel Locked lamp is lit green (steady), and all other lamps are off. (The system normally takes about 1 h to warm up, but may take up to 8 h to warm up, depending on the antenna location and other site-dependent specifics.)
20	The TimeSource 2500 System is now installed and providing Stratum I signals.

Remote Operation via a Modem (Optional)

Use Procedure E to set up communications between BTMONitor and the TimeSource 2500 via a modem (Hayes compatible).

Procedure E. Installing BTMONitor Using a Modem

Step	Action
1	Connect a straight-through serial communications cable (user supplied) between the TimeSource 2500 Remote connector and serial communications port on the modem, and verify all links between the modem and the host computer are connected.
2	From the BTMONitor main screen, click Exit.
3	Open the BTMONitor application. The COMM Port Selection screen appears.

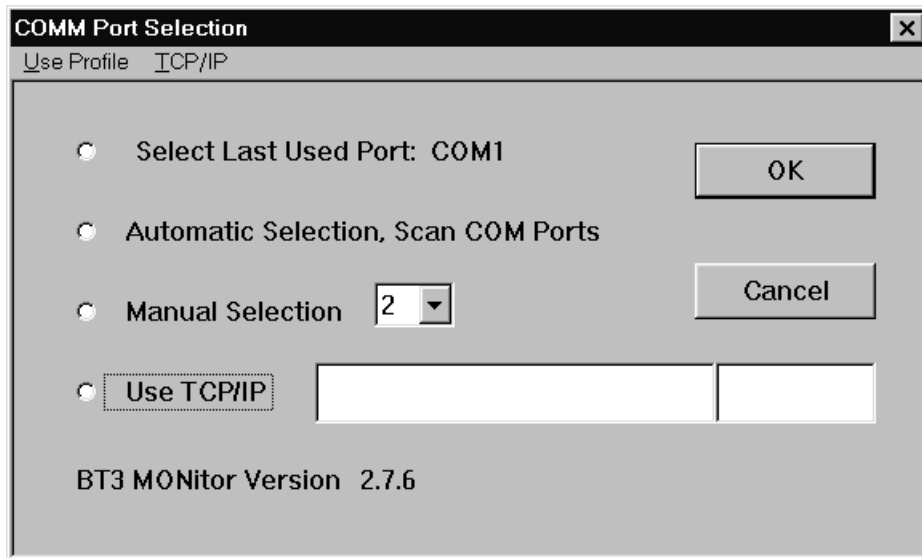

Procedure E. Installing BTMONitor Using a Modem (cont'd)

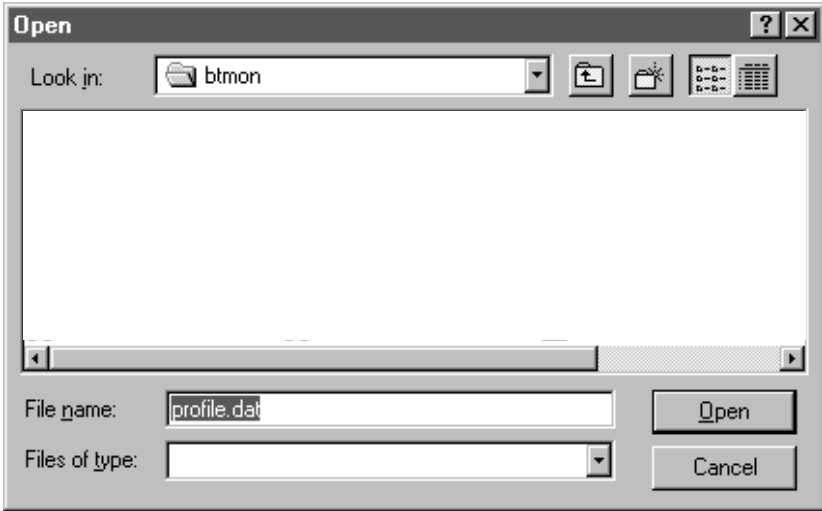
Step	Action
4	<p>On the Comm Port Selection screen, click the User Profile option, on the left of the menu bar. A standard Windows Open File screen appears (shown below), set to open a file named profile.dat. If other profile files have already been created, they will appear in this window.</p> <p><i>Note:</i> The profile.dat file contains up to 10 communication profiles. A communication profile contains modem settings, including phone number, for communicating with a TimeSource 2500 System. Instructions for creating a modem profile follow this paragraph. The profile.dat file can be copied and renamed, using standard Windows procedures (do not change the dat file extension).</p> 

Procedure E. Installing BTMONitor Using a Modem (cont'd)

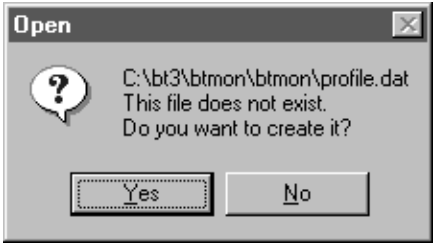
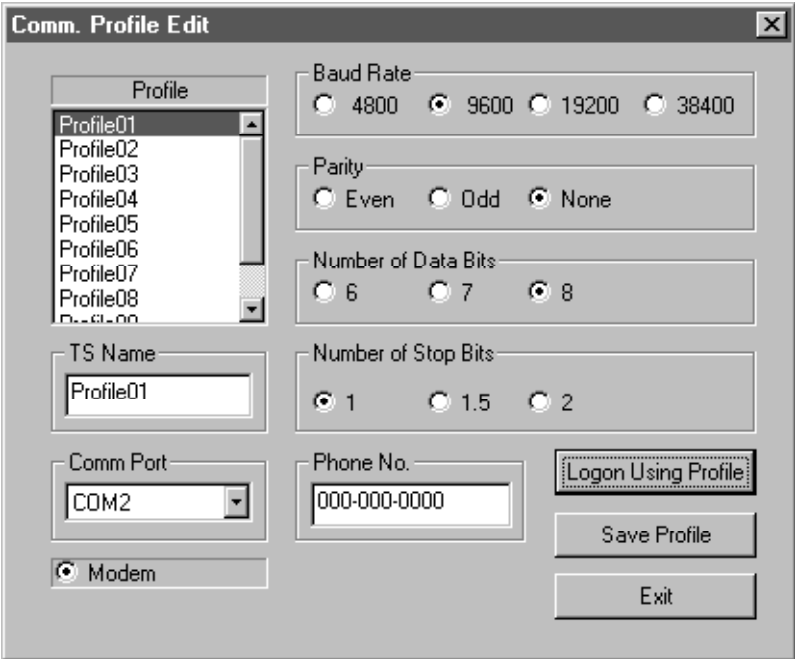
Step	Action
5	<p>Click the Open button. If the file has not yet been created, a dialog box appears (shown below) that asks to create the file profile.dat. If the file has been created, the Comm. Profile Edit screen appears (shown in Step 6).</p> <div data-bbox="481 418 915 659" data-label="Image"></div>
6	<p>Click the Yes button. The Comm. Profile Edit screen appears (shown below).</p> <div data-bbox="299 764 1097 1419" data-label="Image"></div>

Procedure E. Installing BTMONitor Using a Modem (cont'd)

Step	Action
7	<p>On the upper left side of the screen, highlight one of the 10 profiles in the Profile list box. The highlighted selection appears in the TS Name box, below the Profile list box.</p> <p><i>Note:</i> If an accurate profile exists, go to Step 16.</p>
8	<p>In the TS Name box, change the name of the modem profile, if desired. The TS name should reflect the name of the TimeSource 2500 Shelf to which the profile connects.</p>
9	<p>Check that the Comm Port window displays the communication port that is connected to the modem, and that the Modem button is selected.</p>
10	<p>On the right side of the screen, be sure the Baud Rate is 9600, the Parity is None, the Number of Data Bits is 8, and the Number of Stop Bits is 1.</p> <p><i>Caution:</i> Factory settings are displayed on the Comm. Profile Edit screen, and must be used.</p>
11	<p>Enter the phone number for the modem to dial in the Phone No. box.</p>
12	<p>Click the Save Profile button to save the changes made on this screen as the profile named in the TS Name box. A standard Windows Open File screen appears (see Step 4). A file named profile.dat is set to be opened.</p>



Procedure E. Installing BTMONitor Using a Modem (cont'd)

Step	Action
13	<p>Click Open. BTMONitor opens the profile.dat file, enters data from the Comm. Profile Edit screen, and closes the profile.dat file. A confirmation screen appears (shown below).</p> <div data-bbox="327 440 1069 667" data-label="Image">A screenshot of a Windows-style dialog box titled "BTMon". On the left side of the dialog is a warning icon (a triangle with an exclamation mark). To the right of the icon, the text reads "Data Successfully Written to File: C:\bt3\btmon\btmon\Profile.dat". At the bottom center of the dialog is a button labeled "OK". The dialog box has a standard title bar with a close button (X) in the top right corner.</div>
14	<p>Click OK. BTMONitor is now set up to communicate with the TimeSource 2500 via the modem. The Comm. Profile Edit screen appears.</p>
15	<p>If desired, repeat Steps 7 through 14 to create another modem profile.</p>
16	<p>Highlight the appropriate profile and click the Logon Using Profile button.</p> <p><i>Note:</i> Wait approximately 1 min for the connection to be made. After approximately 1 min, either the Successfully Connected or Timed Out (not connected) pop-up screen appears. If the Timed Out pop-up screen appears, check that the modem configuration procedure was correctly followed, then connect again.</p>

Remote Operation via a Terminal Server (Optional)

Use Procedure F to set up communications between BTMONitor and the TimeSource 2500 via a terminal server. This allows the user to select and/or edit the terminal server number and the terminal server port number, to allow the TimeSource 2500 to communicate with the host computer via an LAN network. Consult your system administrator and the manual supplied with your terminal server to determine the server and port numbers.

Note: The following procedure requires a terminal server and a TCP/IP address.

Procedure F. Remote Operation via a Terminal Server

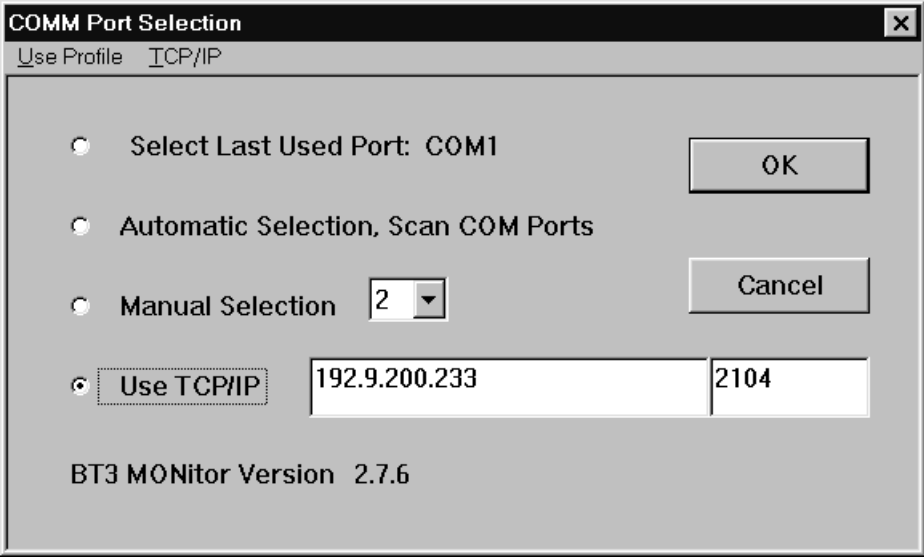
Step	Action
1	From the BTMONitor main screen, click Exit.
2	<p>Open the BTMONitor application. The COMM Port Selection screen appears.</p> 
3	Click Use TCP/IP.
4	Click the TCP/IP option, on the left of the menu bar.
5	<p>Select or edit a terminal server and TCP/IP address by clicking one of the following:</p> <ul style="list-style-type: none">• Select: Selects a terminal server and TCP/IP address• Edit: Edits a terminal server and TCP/IP address. <p>If you click Select, continue to the next step. If you click Edit, skip to Step 7.</p>

Procedure F. Remote Operation via a Terminal Server (cont'd)

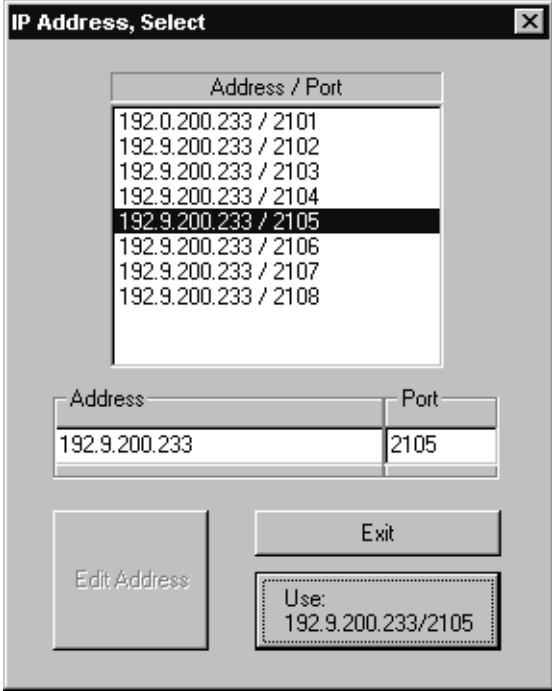
Step	Action
6	<p>In the Address/Port area of the Select IP Address screen (see below), highlight the desired terminal server address and port, then click Use (the Use button will display the selected address and port). Skip to Step 11.</p> 

3

Procedure F. Remote Operation via a Terminal Server (cont'd)

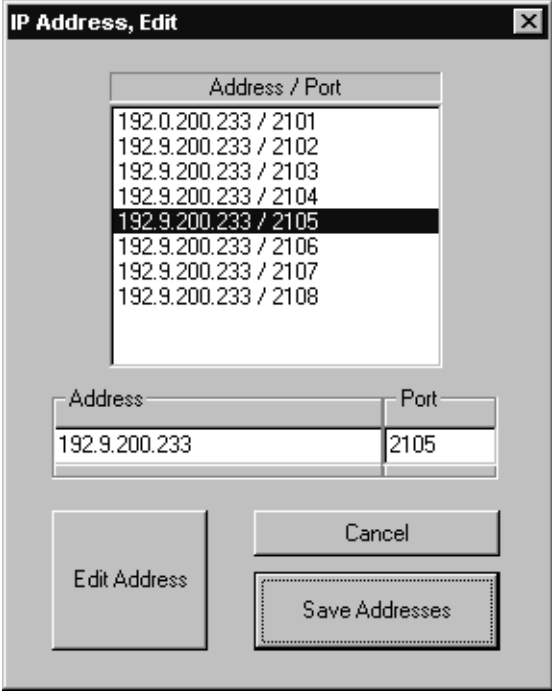
Step	Action
7	<p>In the Address/Port area of the Edit IP Address screen (see below), highlight the terminal server address and port to be edited, then click Edit Address (the Edit Address button will change to Copy to List).</p>  <p>The screenshot shows a dialog box titled "IP Address, Edit". It contains a list of IP addresses and ports. The selected entry is "192.9.200.233 / 2105". Below the list are two input fields: "Address" with the value "192.9.200.233" and "Port" with the value "2105". At the bottom of the dialog are three buttons: "Edit Address", "Cancel", and "Save Addresses".</p>
8	Type the address number, press the tab key, then type the port number.

Procedure F. Remote Operation via a Terminal Server (cont'd)

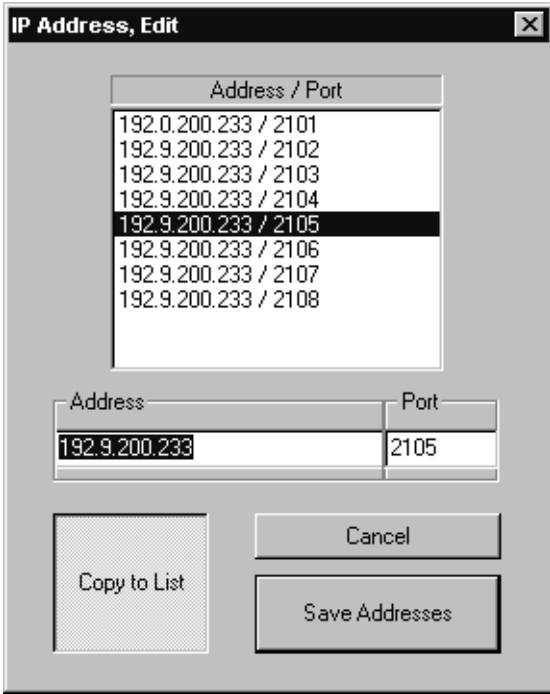
Step	Action
9	<p>Click Copy to List, then click Save Addresses (see below).</p> <div data-bbox="468 357 1021 1047"></div> <p>Note: To select the terminal server address and port just edited, perform the following:</p> <ol style="list-style-type: none">Click the TCP/IP option, on the left of the Comm Port Select screen menu bar; then click Select.Highlight the desired terminal server address and port, then click Use.

.....

Procedure F. Remote Operation via a Terminal Server (cont'd)

Step	Action
10	Click OK.
11	Enter the user name and password for this installation, then click OK.
12	Verify the correct version number and serial port, then click OK.

Operation

This chapter provides tasks which may be required to operate the TimeSource 2500.

Chapter 4

Introduction

The following pages have tasks which may be required to operate the TimeSource 2500.

The System Admin menu functions are only available to the administrator level of security.

View Alarms and Alarm Thresholds

1. Select Status > Alarm Monitor:

2. To determine the status of the GPS input, view the GPS LED:

- Green: indicates locked.
- Yellow: indicates not locked.
- Red: indicates warm-up.

3. To determine the status of the span and remote oscillator inputs, view the Span A, Span B, ROA, and ROB LEDs:

- Gray: indicates not provisioned.
- Yellow: indicates an alarm condition if the input is provisioned, but not ensembled.
- Green: indicates OK.
- Red: indicates an alarm condition.

4. To determine the alarm status, view the Major and Minor LEDs:

- Major: red indicates a major alarm; off indicates no alarm.
- Minor: yellow indicates a minor alarm; off indicates no alarm.

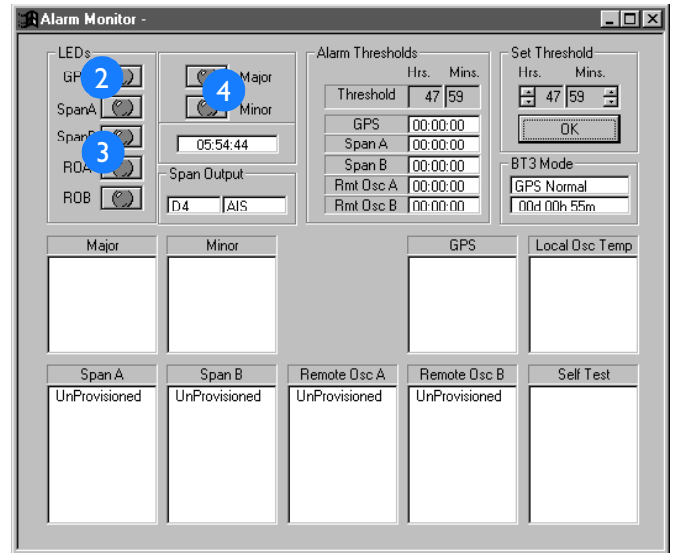
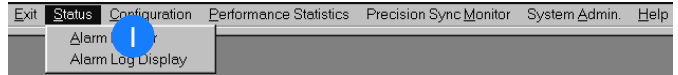

View Alarms and Alarm Thresholds (cont'd)

5. View the listing of major and/or minor alarm messages.

6. View the listing of transient events and alarm messages for the optional inputs, GPS, local oscillator temperature, and self-test.

See the Troubleshooting chapter for explanations of the messages.

7. View the alarm thresholds.

Threshold shows the amount of time a minor alarm exists before escalating to a major alarm. GPS, Span A, Span B, Rmt Osc A, and Rmt Osc show the amount of time an item has been in minor alarm.

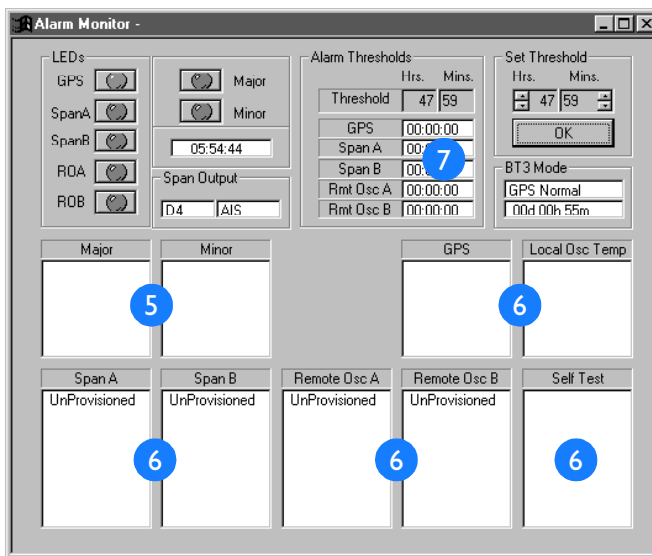

Change Alarm Thresholds

1. Select Status > Alarm Monitor:

2. To set the amount of time a minor alarm exists before becoming a major alarm, use the Hrs. and Mins. up and down arrows.

For GPS inputs, this also sets the amount of time from the beginning of bridging mode to escalation to a minor alarm. The system stays in bridging mode for 25% of the programmed threshold. For example, if the threshold is 48 hours, and the GPS input is lost, the system stays in bridging mode for 12 hours (25% of 48 hours), then escalates to a minor alarm. If GPS input loss continues for 48 hours from the start of bridging mode, the system escalates to a major alarm.

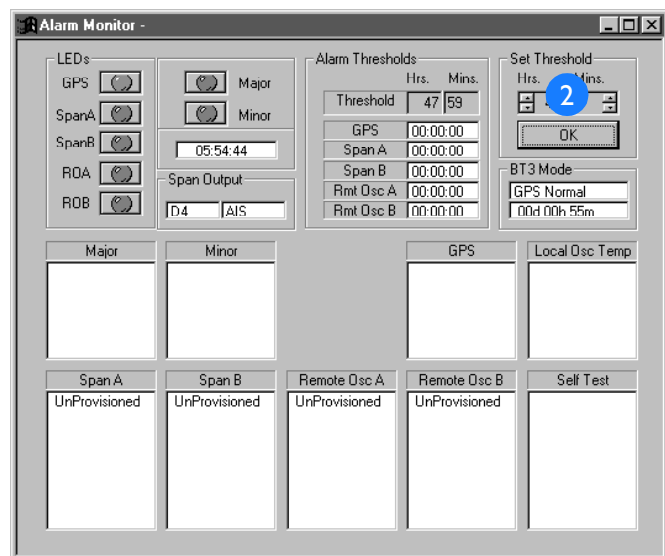
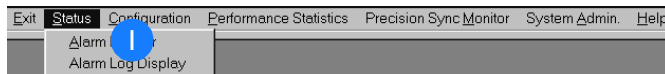

Caution: Do not set the threshold to less than 12 hours — spurious alarms may result.

Notes:

- The recommended setting is 48 hours (factory setting).
- The threshold setting only affects span and remote oscillator inputs if they are provisioned and ensembled.

Change Alarm Thresholds (cont'd)

3. To save the alarm threshold settings, click OK.

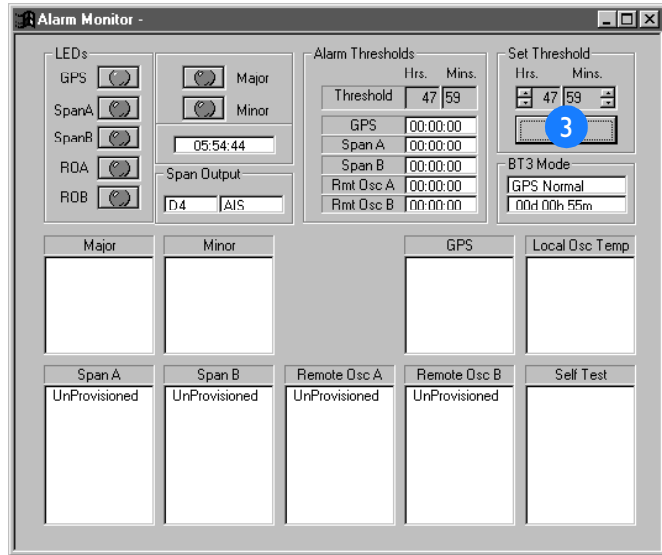

View Span Framing and Trouble Code Sent During Major Alarm

1. Select Status > Alarm Monitor:

2. View the framing type and trouble code that will be sent on Span A and B during a major alarm.

Note: Span Output does not indicate real-time activity or the current state of the outputs.

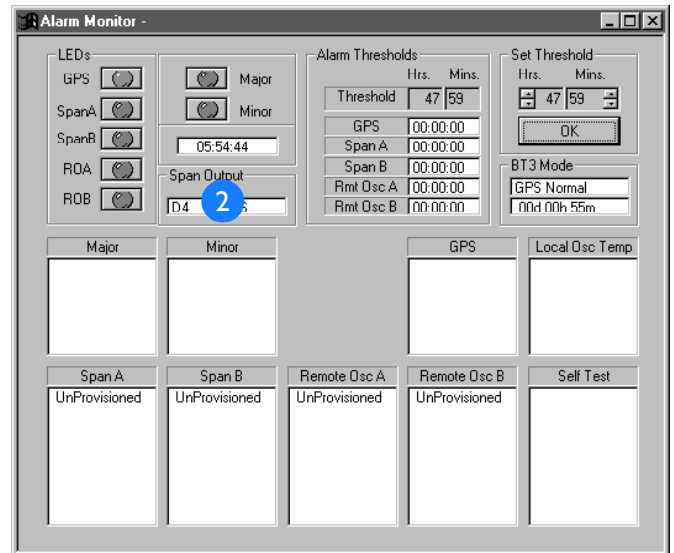
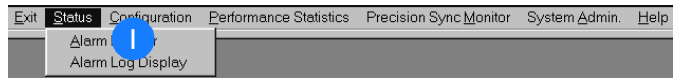

View BT3 (TimeSource 2500) Mode and Duration

1. Select Status > Alarm Monitor:

2. View the current BT3 (TimeSource 2500) mode, and the amount of time the unit has been in that mode.

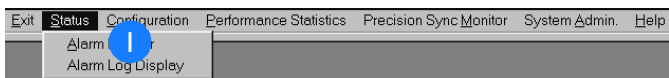

The TimeSource 2500 will be in one of four modes:

- GPS Normal: indicates the system is operating without any GPS events or alarm conditions.
- Bridging: indicates the system is operating with a transient GPS event. Bridging does not indicate a problem that requires maintenance.
- Holdover: occurs when a GPS event has escalated because the event has not cleared; i.e., bridging has escalated to holdover because the GPS event keeps occurring. Holdover also results in a minor alarm. Holdover does not indicate a loss of timing output quality until a major alarm is also declared.
- Warm-up: indicates the system is in a power-up state. Timing outputs will not be generated until the system exits warm-up.

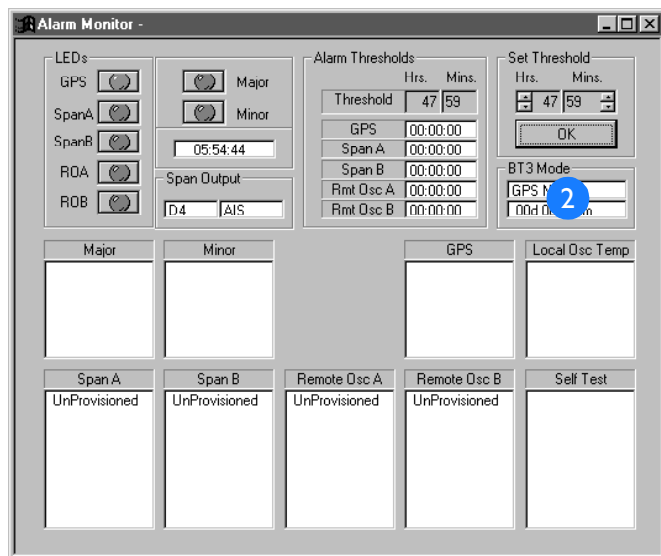

View Alarm Log

1. Select Status > Alarm Log Display.
2. View the most recent 512 alarms and events.

Minor alarms are highlighted yellow, major alarms are highlighted red, and cleared alarms and power-up information are highlighted green.

Refer to the Troubleshooting chapter for a list of messages that may appear in the log.

3. To update the log information, click Refresh.
4. To start or stop the log file for this screen, click Select Log to File.

If checked, data from the screen is written to the file at every screen update. The log file may be opened and read during the logging process, however, the log file is read-only during the logging process. The log file is written in a comma-delimited (.csv) data format.

5. To exit, click Exit.

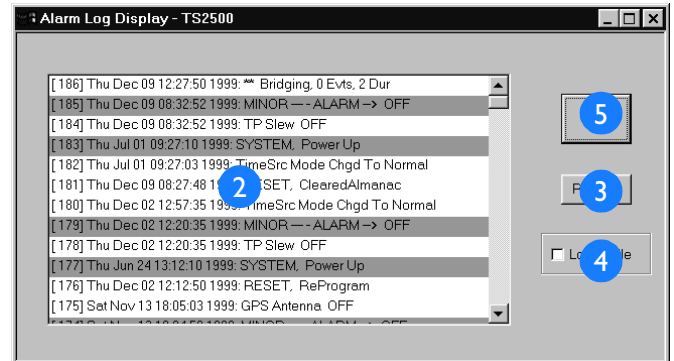
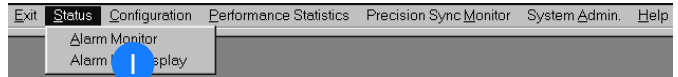

Clear Alarm Log

1. Select System Admin > Reset.
2. To clear the alarm log in the Alarm Log Display screen, select Reset Flash Alarm Log Data.
3. To reset the selected item, click RESET. To ignore any information, click Cancel.

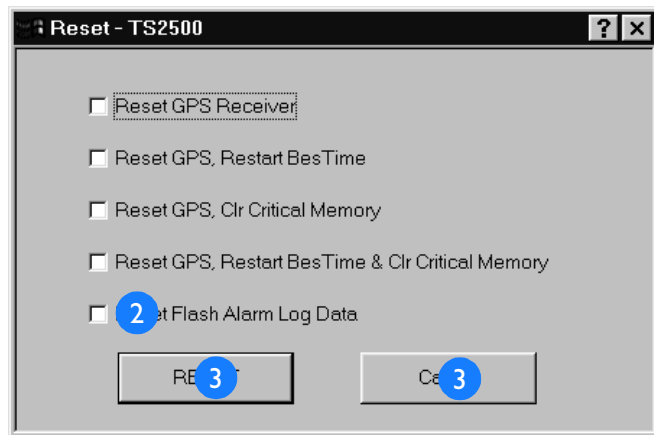
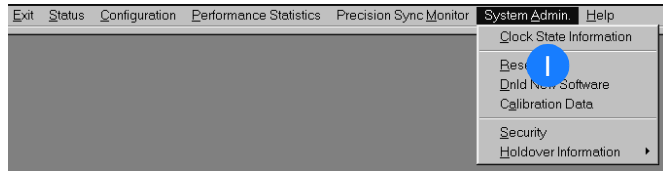

Change Location ID

1. Select Configuration > Installation.
2. Type in the TimeSource 2500 identification.

The identification must be from two to eight alphanumeric characters. The identification name can be used to identify this particular TimeSource 2500 System among multiple TimeSource 2500 Systems.

3. To save the information on this screen to the TimeSource 2500, click Save to TimeSource.
4. To save the contents of the screen to a file, click Save to File.
5. To ignore any changed information and close this screen, click Cancel.
6. To open a saved installation configuration, click Open From File.

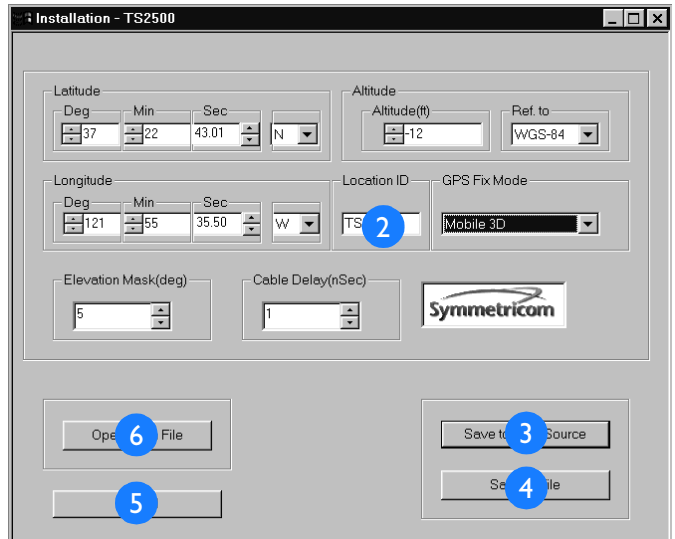
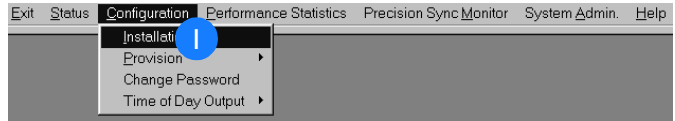

Change Elevation Mask

1. Select Configuration > Installation.
2. To set the antenna elevation mask from the horizon to this number of degrees, use the Elevation Mask(deg) arrow keys.
3. To save the information on this screen to the TimeSource 2500, click Save to TimeSource.
4. To save the contents of the screen to a file, click Save to File.
5. To ignore any changed information and close this screen, click Cancel.
6. To open a saved installation configuration, click Open From File.

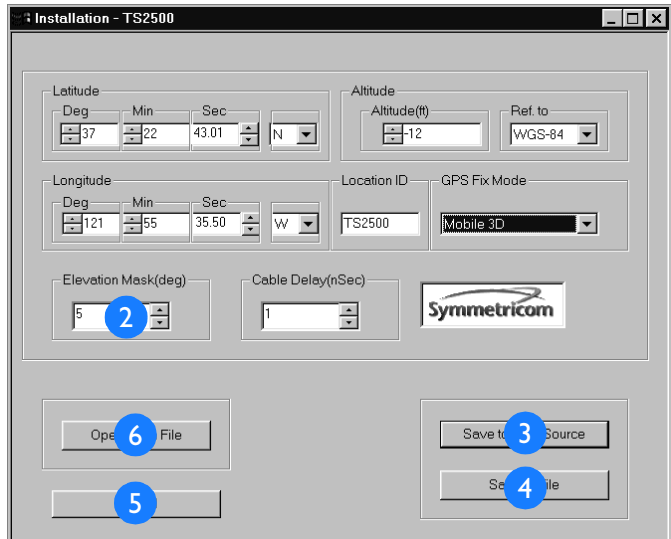
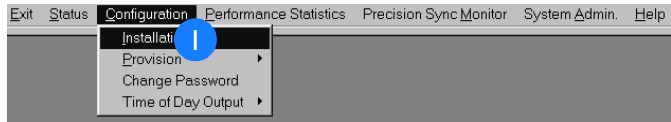

Enable or Disable Inputs

1. Select Configuration > Provision > Inputs.
2. To enable (provision) or disable monitoring of an input, select or de-select any of the input source(s).

Caution: Do not select an unused input, otherwise, spurious alarms will be generated.

Note: An input must be provisioned before it can be ensembled.

3. To restore the factory settings, select Restore Defaults.
4. To save the input selections, click OK. To ignore any changed information, click Cancel.

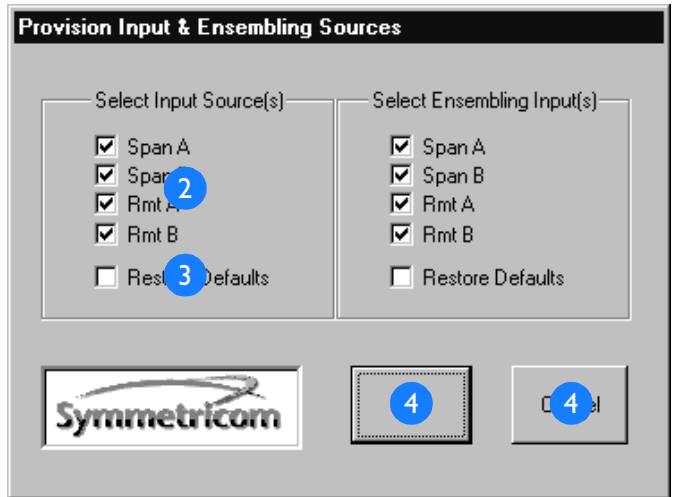
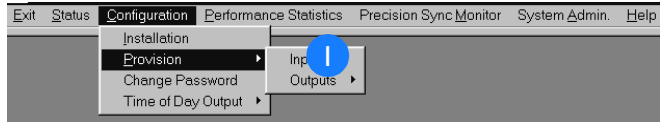

Ensemble Inputs or Exclude Inputs from Ensemble

1. Select Configuration > Provision > Inputs.

2. To include any of the enabled (provisioned) inputs in the BesTime output ensemble, select the input. To exclude from the ensemble, de-select.

Ensembling means the input(s) are used by the system to generate the timing outputs, and will impact the timing performance of the outputs.

Note: An input must be enabled (provisioned) before it can be ensembled.

3. To restore the factory settings, select Restore Defaults.

4. To save the ensembling selections, click OK. To ignore any changed information, click Cancel.

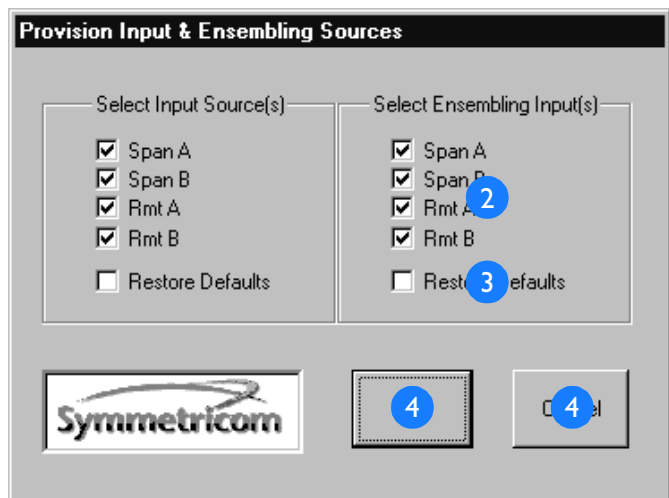
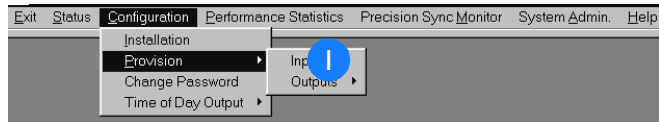

View Input Weighting and Gear

1. Select Performance Statistics > System Loop Statistics.
2. View the weight given to each input for BesTime ensembling computation.
3. View the stage (gear) in the time calculation process.

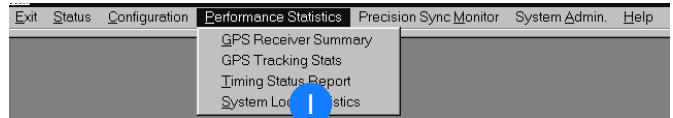

Gears 1, 2, and 3 are warm-up processes after power-up. Gears 4, 5, and 6 indicate a settling period when the TimeSource 2500 outputs Stratum 1 signals. Gear 7 indicates steady-state operation.

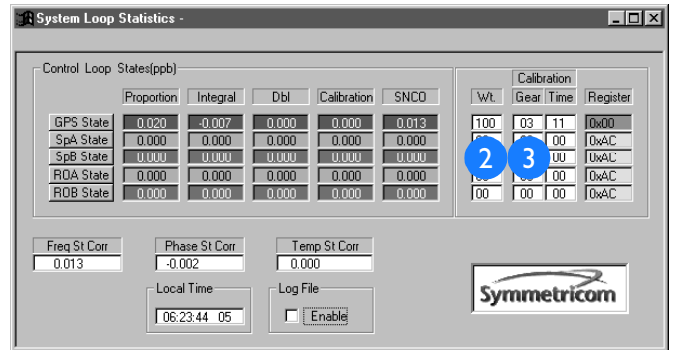

View Input Performance Statistics

1. Select Precision Sync Monitor:

2. View the accumulation period for the data, in seconds.

3. View the statistics data, which is the report of the measurement difference between the provisioned inputs and the TimeSource 2500 output.

This data can be plotted and compared against any one of several timing performance masks, to gauge the quality of the timing being received on the input(s). Timing performance mask(s) and spreadsheet software are not available from Symmetricom, and must be obtained from third party vendors.

4. View the phase data, which is the phase offset, in ns, for each input used in the BesTime calculation.

5. To include statistics data in the log file, select Statistics.

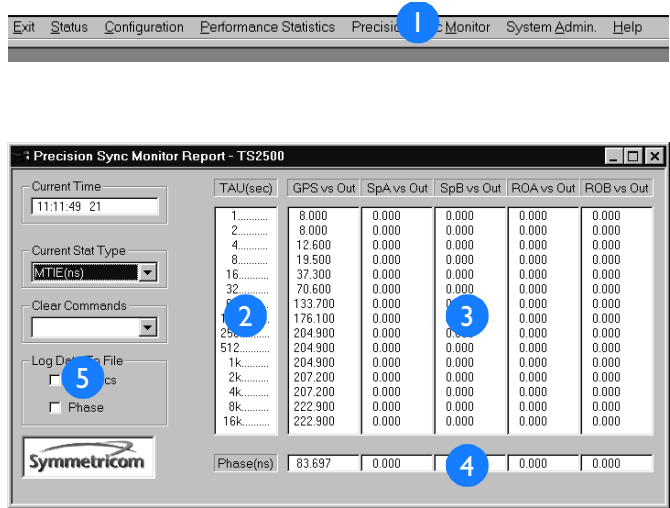

View Input Performance Statistics (cont'd)

6. To include phase data in the log file, select Phase.

Data from the screen is written to the file at every screen update. The log file may be opened and read during the logging process, however, the log file is read-only during the logging process. The log file is written in a comma-delimited (.csv) data format.

	TAU(sec)	GPS vs Out	SpA vs Out	SpB vs Out	ROA vs Out	ROB vs Out
1.....	8.000	0.000	0.000	0.000	0.000	0.000
2.....	8.000	0.000	0.000	0.000	0.000	0.000
4.....	12.600	0.000	0.000	0.000	0.000	0.000
8.....	19.500	0.000	0.000	0.000	0.000	0.000
16.....	37.300	0.000	0.000	0.000	0.000	0.000
32.....	70.600	0.000	0.000	0.000	0.000	0.000
64.....	133.700	0.000	0.000	0.000	0.000	0.000
128.....	176.100	0.000	0.000	0.000	0.000	0.000
256.....	204.900	0.000	0.000	0.000	0.000	0.000
512.....	204.900	0.000	0.000	0.000	0.000	0.000
1k.....	204.900	0.000	0.000	0.000	0.000	0.000
2k.....	207.200	0.000	0.000	0.000	0.000	0.000
4k.....	207.200	0.000	0.000	0.000	0.000	0.000
8k.....	222.900	0.000	0.000	0.000	0.000	0.000
16k.....	222.900	0.000	0.000	0.000	0.000	0.000
Phase(ns)	83.697	0.000	0.000	0.000	0.000	0.000

7. To set the type of measurement to show in the statistics data columns, use the Current Stat Type pull-down arrow.

8. To set the data to be cleared in the statistics data columns, use the Clear Commands pull-down arrow.

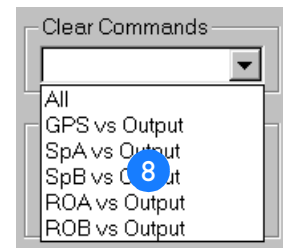
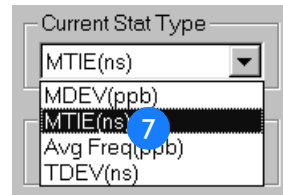

Set Span Framing and Trouble Code Sent During Major Alarm

1. Select Configuration > Provision > Outputs.

2. For D4 framing, select D4, then one of these:

- AIS on Error
- Squelch on Error

3. For ESF framing, select ESF, then one of these:

- AIS on Error
- Squelch on Error
- SSM, then one of these:
 - STU: Synchronization traceability unknown
 - ST2: Stratum 2
 - ST3: Stratum 3
 - DUS: Do not use for synchronization

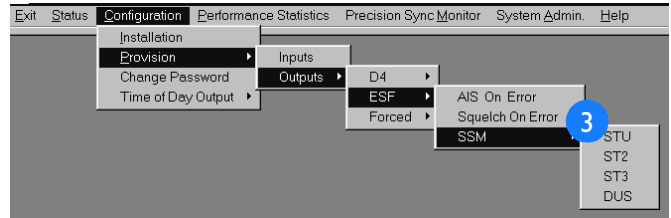
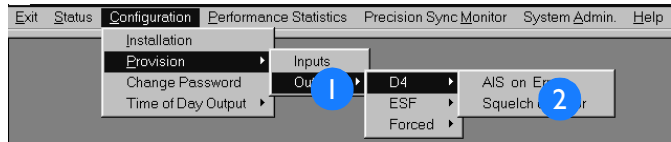

Notes:

- If SSM is selected, the recommended setting is either STU or ST2.
- SSM messages communicate to downstream network elements the timing performance received on an incoming signal.

Set Span Framing and Trouble Code Sent During Major Alarm (cont'd)

4. For a forced output, select Forced, then one of these:

- AIS Output
- Squelch Output
- D4
- ESF, then an SSM quality level:
 - PRS: Primary reference source
 - STU: Synchronization traceability unknown
 - ST2: Stratum 2
 - ST3: Stratum 3
 - DUS: Do not use for synchronization
 - ST4: Stratum 4
 - SIC: SONET internal clock 20 ppm

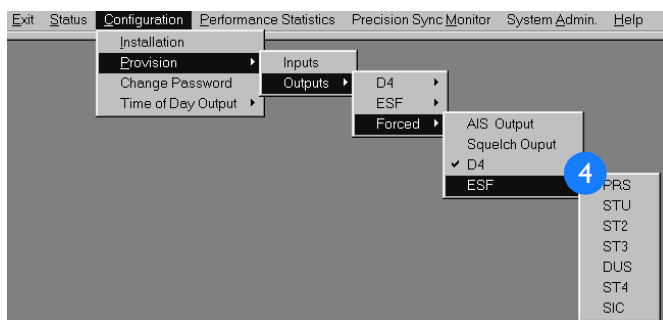

Any of the selections under Forced forces the Span A and B outputs into a particular mode. Forced mode may be useful for testing and troubleshooting. Forced mode may also be useful in applications where the outputs generated by the TimeSource 2500, even in major alarm, may be better than the alternative (e.g., offices without additional holdover clocks in a distribution shelf).

Set TOD Output Format

1. Select Configuration > Time of Day Output.

2. To set the desired TOD output format, select NTP Type 4, Cisco Format, or None.

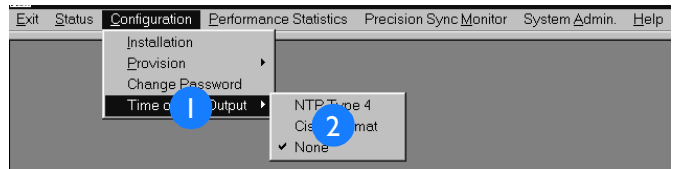

Note: If None is selected, TOD will be disabled.

View GPS Tracking Statistics

1. Select Performance Statistics > GPS Tracking Stats.

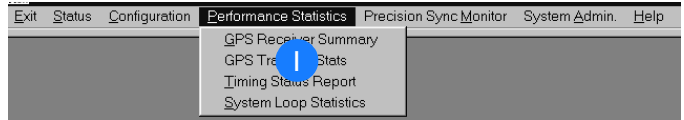

2. View the number of minutes the receiver has been locked during each hour of the last 24 hours.

Note: On power-up, 60 minutes is shown for every hour. Actual data for each hour will appear, as the system cycles through the first 24 hours of operation after power-up.

3. View the number of minutes the TimeSource 2500 has been locked during the last 24 hours.

4. View the percentage of the last 24 hours that the TimeSource 2500 was locked to at least one satellite.

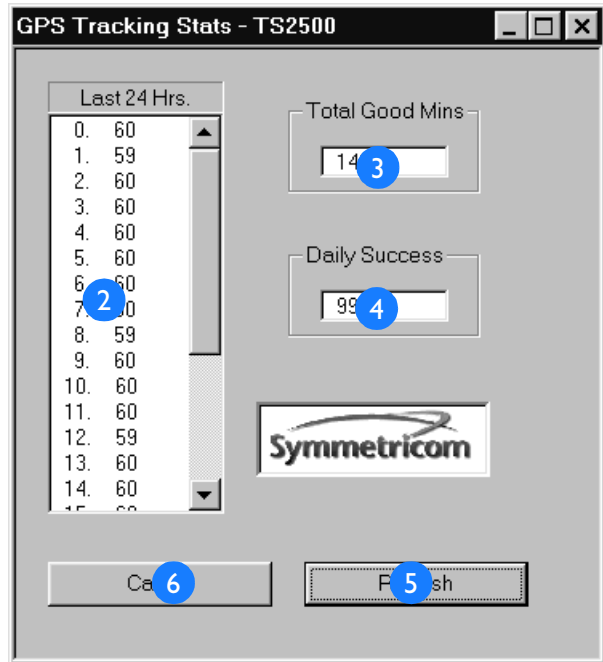

Note: The daily success rate must be greater than 40%. If not, refer to the Troubleshooting chapter.

5. To update the information, click Refresh.

6. To exit, click Cancel.

View GPS Satellite Information

1. Select Performance Statistics > GPS Receiver Summary.

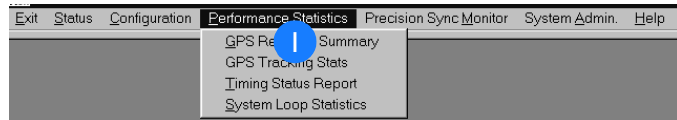

2. View information about each GPS satellite currently being tracked.

- Satellite: Satellite number.
- C/No(dB): Carrier-to-noise ratio. Measurement of the strength of the satellite signal relative to noise.
- Elevation: position of the satellite in degrees above the horizon.
- Azimuth: position of the satellite in degrees clockwise from true north.
- Lock: Number of seconds since the TimeSource 2500 acquired lock on the satellite (count stops at 2500). Zero indicates the system is not locked to the satellite.

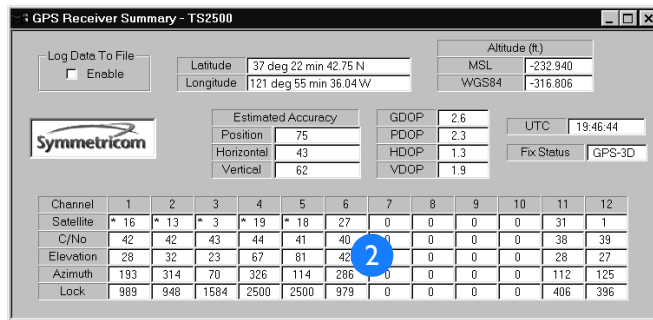

View GPS Satellite Information (cont'd)

3. To start or stop the log file for this screen, select Log Data To File.

Data from the screen is written to the file every 60 seconds while the box is checked. The log file may be opened and read during the logging process; however, the log file is read-only during the logging process. The log file is written to the host computer disk in a comma-delimited (.csv) data format.

Channel	1	2	3	4	5	6	7	8	9	10	11	12
Satellite	* 16	* 13	* 3	* 19	* 18	27	0	0	0	0	31	1
C/N ₀	42	42	43	44	41	40	0	0	0	0	38	39
Elevation	28	32	23	67	81	42	0	0	0	0	28	27
Azimuth	193	314	70	326	114	286	0	0	0	0	112	125
Lock	989	948	1584	2500	2500	979	0	0	0	0	406	396

4. View the latitude and longitude of the TimeSource 2500.

5. View the altitude (in feet) of the TimeSource 2500.

6. View the Universal Coordinated Time.

7. View the GPS receiver system mode of operation, as determined by the system. GPS-3D indicates four or more satellites are in view of the TimeSource 2500. No Fix indicates less than four satellites are in view of the TimeSource 2500.

View Daily Holdover Information

1. Select System Admin > Holdover Information > Daily.
2. To see the data for selected input, select Select > Display, then select the desired input.
3. View the data of the 4 hour time period.

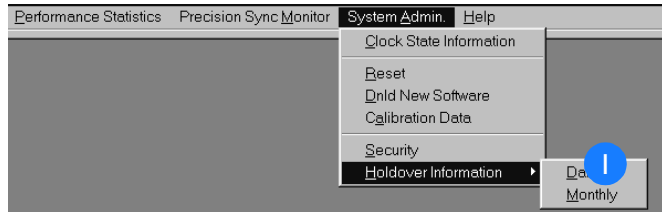

The time is indicated as hours of a 24 hour clock.

4. View the average measured frequency offset during the 4 hour period, in parts per billion (ppb).
5. View the predicted frequency offset during the 4 hour period, in parts per billion (ppb).

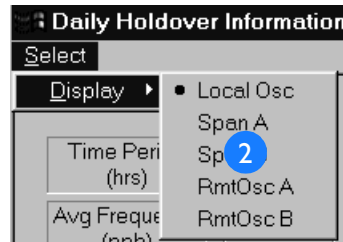
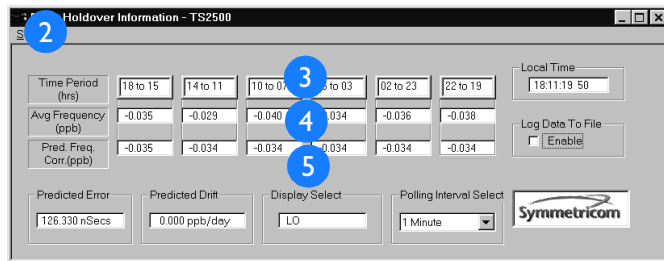

View Daily Holdover Information (cont'd)

6. To start or stop the log file for this screen, select or de-select Log Data To File.

Data from the screen is written to the file at every screen update while the box is checked. The log file may be opened and read during the logging process; however, the log file is read-only during the logging process. The log file is written in a comma-delimited (.csv) data format.

Time Period (hrs)	18 to 15	14 to 11	10 to 07	06 to 03	02 to 23	22 to 19	Local Time
Avg Frequency (ppb)	-0.035	-0.029	-0.040	-0.034	-0.036	-0.038	18:11:19.50
Pred. Freq. Corr (ppb)	-0.035	-0.034	-0.034	-0.034	-0.034	-0.034	Log Data To File <input checked="" type="checkbox"/>
Predicted Error	126 ns						
Predicted Drift	0.01 ppy						
Display Select	LO						
Polling Interval Select	1 Minut						

7. To set the number of minutes between screen updates, use the Polling Interval Select pull-down arrow.

8. View which input is being measured.

9. View the drift, in parts per billion per day, predicted for this input during the current 24 hour period.

10. View the predicted error in ns.

This error can be held for up to 24 hours if the TimeSource 2500 goes into holdover.

View Monthly Holdover Information

1. Select System Admin > Holdover Information > Monthly.
2. To see the data for the selected input, select Select > Display, then select the desired input.
3. View the data of the 4 day time period.

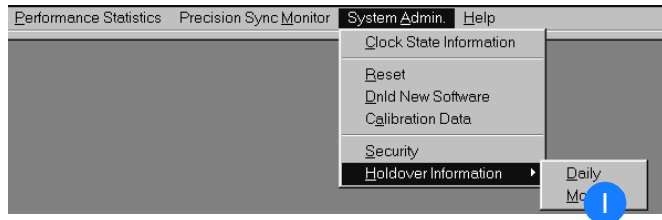

The time is indicated as days of a 30 day month.

4. View the average measured frequency offset during the 4 day period, in parts per billion (ppb).
5. View the average predicted time error during the 4 day period, in nanoseconds (ns).

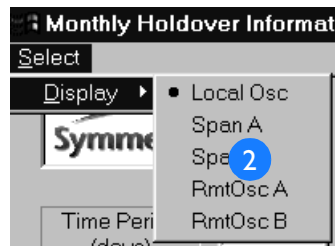
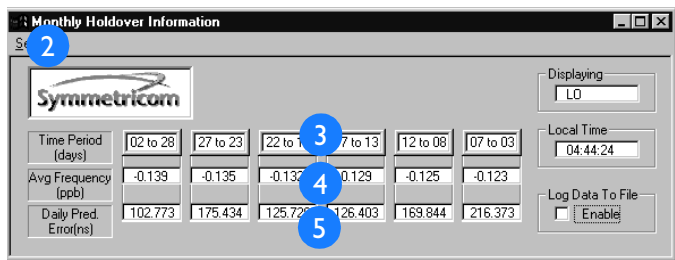

View Monthly Holdover Information (cont'd)

6. View which input is being measured.

7. To start or stop the log file for this screen, select or de-select Log Data To File.

Data from the screen is written to the file at every screen update while the box is checked. The log file may be opened and read during the logging process; however, the log file is read-only during the logging process. The log file is written in a comma-delimited (.csv) data format.

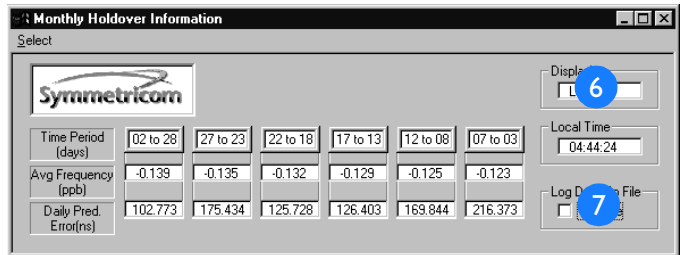

Reset GPS Receiver and System

1. Select System Admin > Reset.
2. To reset the GPS receiver processor; and restart the satellite signal search, select Reset GPS Receiver.
3. To reset the system processor, select Reset GPS, Restart BesTime.

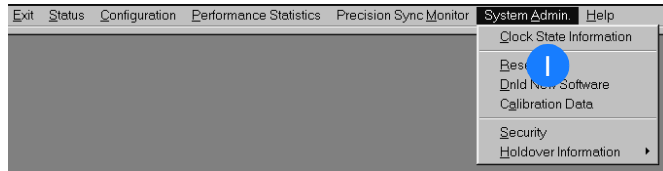

Caution: This will cause a disruption in service.

4. To reset the GPS receiver processor; and clear the critical memory, including the data entered on the Installation screen, select Reset GPS, Clr Critical Memory.

Caution: This will cause a disruption in service.

5. To reset the system processor, and clear the critical memory, including the data entered on the Installation screen, select Reset GPS, Restart BesTime & Clr Critical Memory.

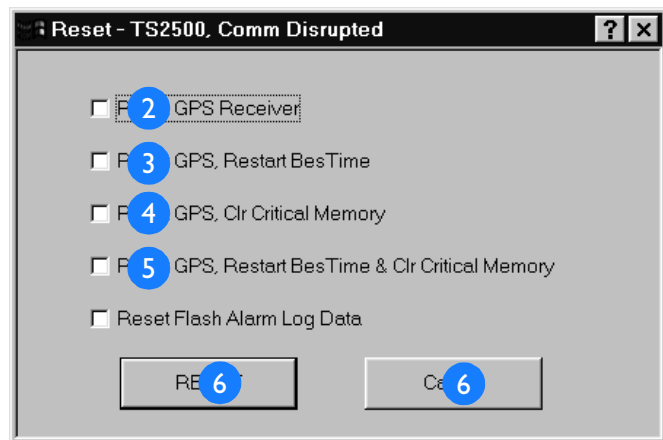

Caution: This will cause a disruption in service.

6. To reset the selected item, click RESET. To ignore any information, click Cancel.

Download New Software

1. Select System Admin > Dnld New Software.

Notes:

- a. New software should not be downloaded over a modem connection. Use a direct connection only.
- b. The TimeSource 2500 does not lose data during a software download/upgrade.
- c. The TimeSource 2500 enters bridging mode during the software loading process, and exits bridging mode when it receives its first good GPS measurements after the download.

2. Select the name of the file to download to the Timesource 2500.

3. When the desired file is shown, click OK. To cancel the current operation, click Cancel.

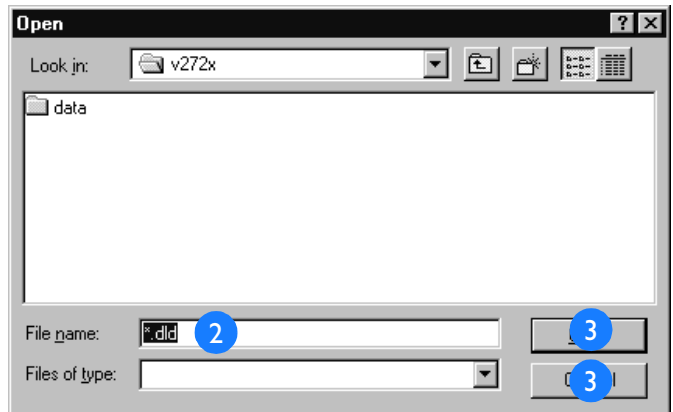
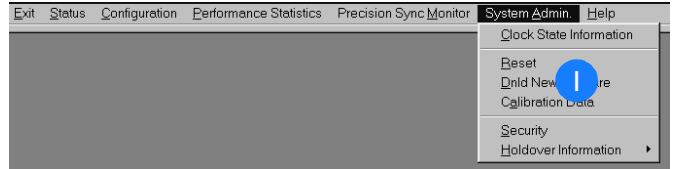

Download New Software (cont'd)

- Verify the file name is correct.
- Verify the baud rate is set to 19200. Do not use any other baud rate.
- To continue the downloading process, click Continue. To cancel the downloading process (if desired), click Cancel.

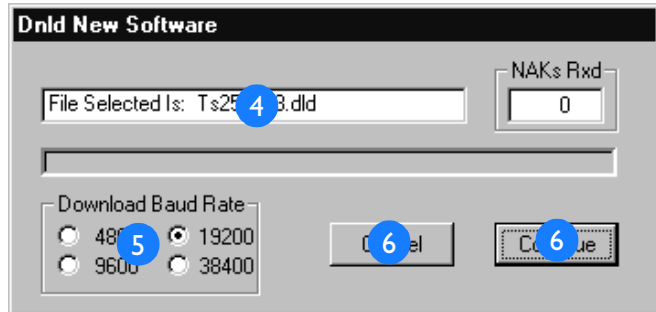

A progress bar and messages track the download process.

- Once the download is complete, a message appears. Click OK.
- The TimeSource 2500 breaks, then reestablishes, communication with the host computer, and a message appears. Click OK.
- To exit the application, click Exit when the BTMONitor main screen appears.
- To use the upgraded software, restart BTMONitor. (Double-click the BTMONitor icon on the desktop.)

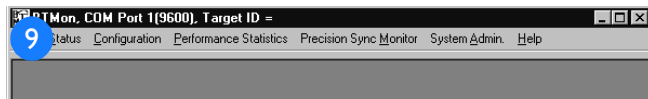
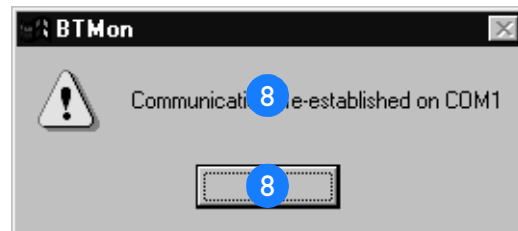
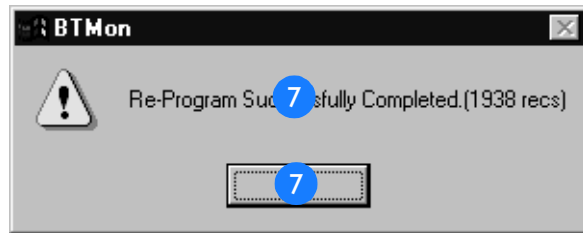

View User Accounts

1. Select System Admin > Security.

2. View the list of system users and their privilege levels:

- Administration: Allows a user to change any parameter or function.
- Manage: Allows a user to view and change any parameter or function except: restart the system, download new firmware, and manage user security.
- Reports: Allows a user to view, but not change, the operational parameters of the system.
- None: Disables all privileges of a user, while keeping the user information.

3. To exit, Click OK or EXIT.

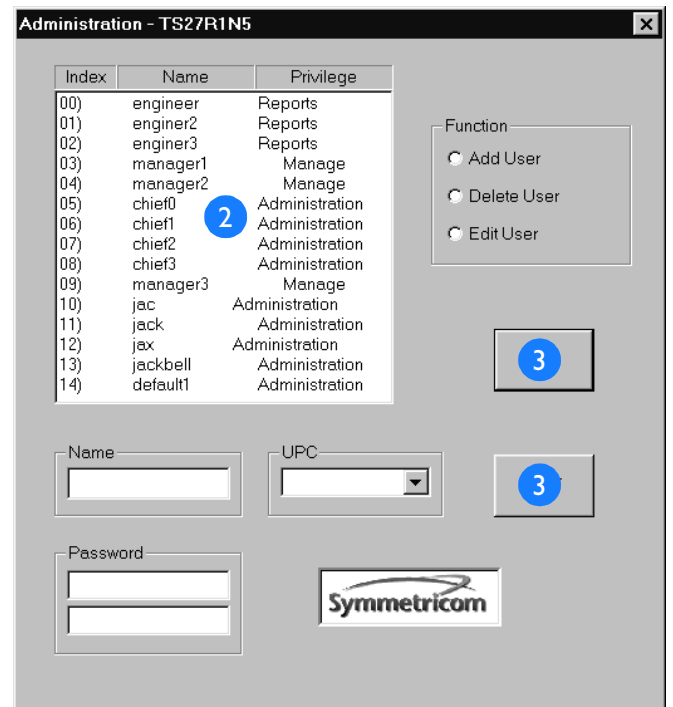
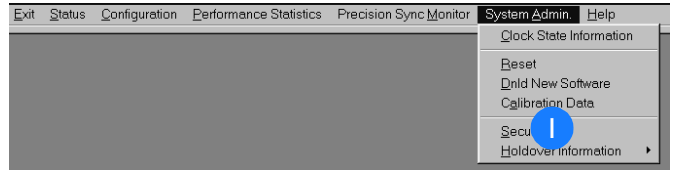

Add User Account

1. Select System Admin > Security.
2. Select Add User.
3. Type in a name for the new user account.

No two users can have the same name. The name must have three to eight characters.

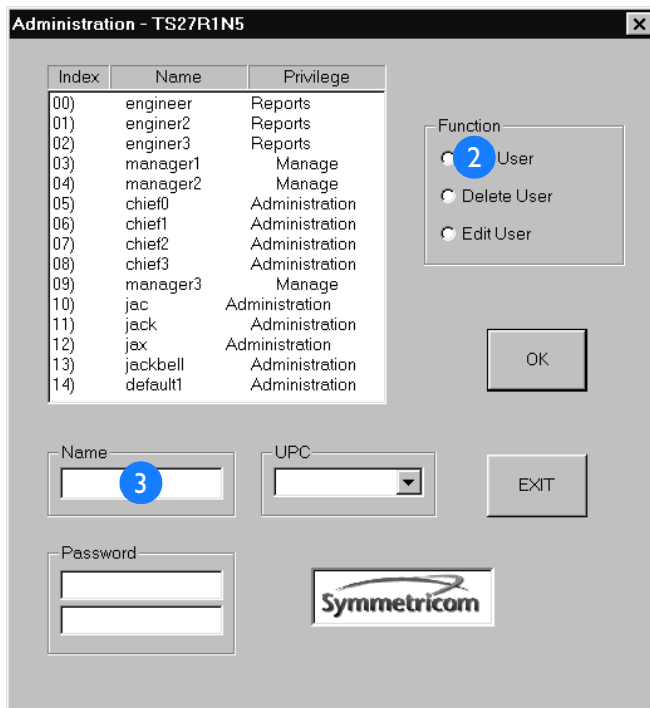
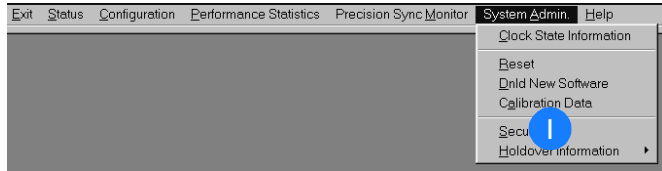

Add User Account (cont'd)

4. To select the privilege level for the new user account, use the UPC pull-down arrow:

- Administration: Allows a user to change any parameter or function.
- Manage: Allows a user to view and change any parameter or function except: restart the system, download new firmware, and manage user security.
- Reports: Allows a user to view, but not change, the operational parameters of the system.
- None: Disables all privileges of a user, while keeping the user information.

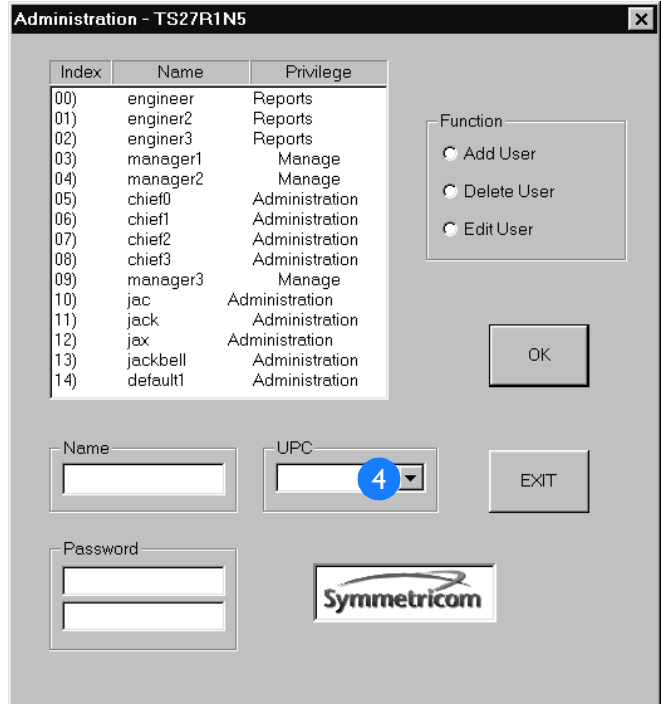

Add User Account (cont'd)

5. Type in the password for the new user account in both of the Password windows.

A user name cannot be in the user's password. The password must be from six to eight characters, must include at least one alphabetic and one numeric character, and must contain at least one of the following special characters: ! " # \$ % & ' () * + , - . / : ; < = > ? @

6. To save the information to the TimeSource 2500, click OK. To ignore any changed information, click Exit.

The screenshot shows the 'Administration - TS27R1N5' window. It features a table of existing users, a 'Function' panel with radio buttons for 'Add User', 'Delete User', and 'Edit User', and input fields for 'Name', 'UPC', and 'Password'. A blue circle with the number '5' is placed over the Password input field, and another blue circle with the number '6' is placed over the OK button in the bottom right corner.

Index	Name	Privilege
00)	engineer	Reports
01)	engine2	Reports
02)	engine3	Reports
03)	manager1	Manage
04)	manager2	Manage
05)	chief0	Administration
06)	chief1	Administration
07)	chief2	Administration
08)	chief3	Administration
09)	manager3	Manage
10)	jac	Administration
11)	jack	Administration
12)	jax	Administration
13)	jackbell	Administration
14)	default1	Administration

Function

Add User

Delete User

Edit User

Name:

UPC:

Password:

Symmetricon

Delete User Account

1. Select System Admin > Security.
2. Select Delete User.
3. Select the user account to be deleted.
4. To save the information, click OK. To ignore any changed information, click Exit.

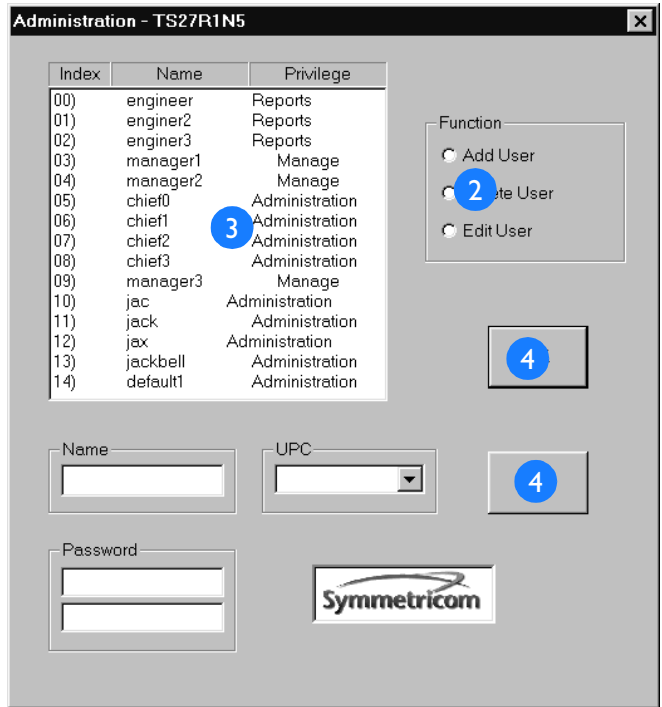
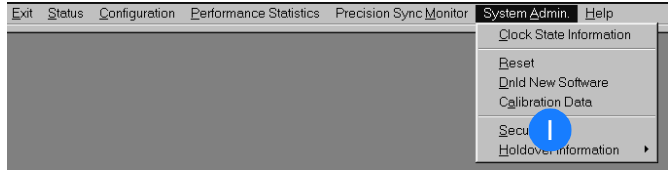

Edit User Account

1. Select System Admin > Security.
2. Select Edit User.
3. Select the user account to be edited.
4. If desired, type in a new name for the user account.

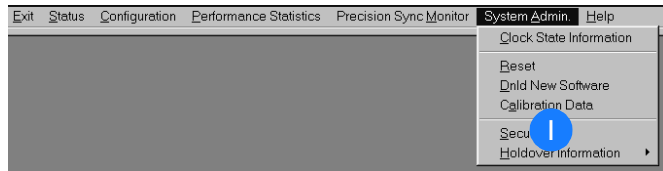

No two users can have the same name. The name must have three to eight characters.

5. To select the new privilege level for the user account (if desired), use the UPC pull-down arrow.

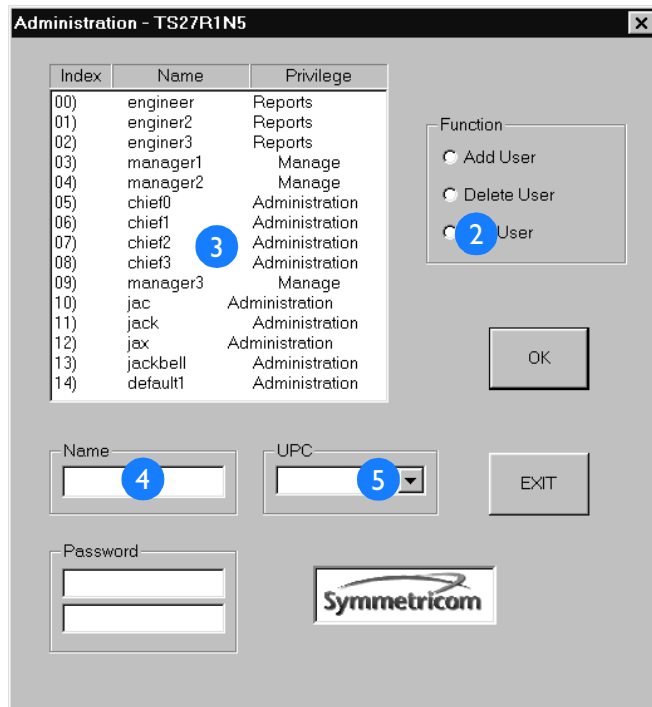

Edit User Account (cont'd)

6. If desired, type in the new password for the user account in both of the Password windows.

A user name cannot be in the user's password. The password must be from six to eight characters, must include at least one alphabetic and one numeric character, and must contain at least one of the following special characters: ! " # \$ % & ' () * + , - . / : ; < = > ? @

7. To save the information, click OK. To ignore any changed information, click Exit.

The screenshot shows the Symmetricom Administration - TS27R1N5 window. It features a table of users, a 'Function' section with radio buttons, and form fields for Name, UPC, and Password. A blue circle with the number 6 is overlaid on the Password field, and a blue circle with the number 7 is overlaid on the OK button.

Index	Name	Privilege
00)	engineer	Reports
01)	engineer2	Reports
02)	engineer3	Reports
03)	manager1	Manage
04)	manager2	Manage
05)	chief0	Administration
06)	chief1	Administration
07)	chief2	Administration
08)	chief3	Administration
09)	manager3	Manage
10)	jac	Administration
11)	jack	Administration
12)	jax	Administration
13)	jackbell	Administration
14)	default1	Administration

Function

Add User

Delete User

Edit User

Name:

UPC:

Password:

Symmetricom

Change Password

1. Select Configuration > Change Password.

2. Type in the user name (case sensitive) for this system (factory-set to default).

3. Type in the user password (case sensitive) for this system (factory-set to TS2500:).

4. Type in the new password.

The password must be from six to eight characters, must include at least one alphabetic and one numeric character, and must contain at least one of the following special characters: ! " # \$ % & ' () * + , - . / : ; < = > ? @

5. Type in the new password again.

6. To save the information, click OK. To ignore any changed information, click Cancel.

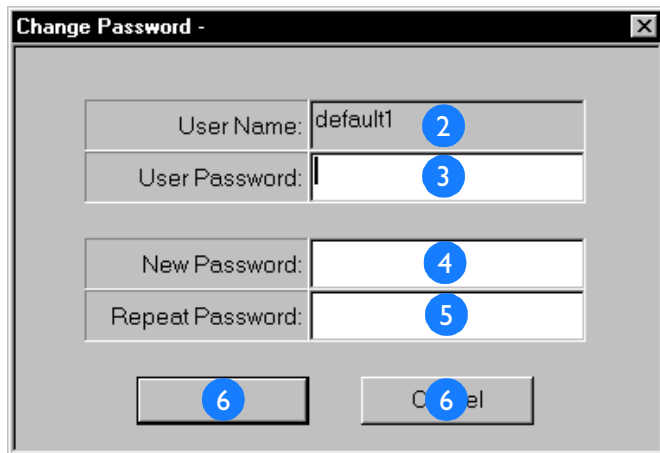
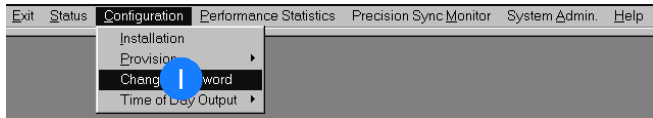

View BTMONitor Software Version

1. Select Help > About BTMon.
2. View the BTMONitor software version.
3. To exit, click OK.

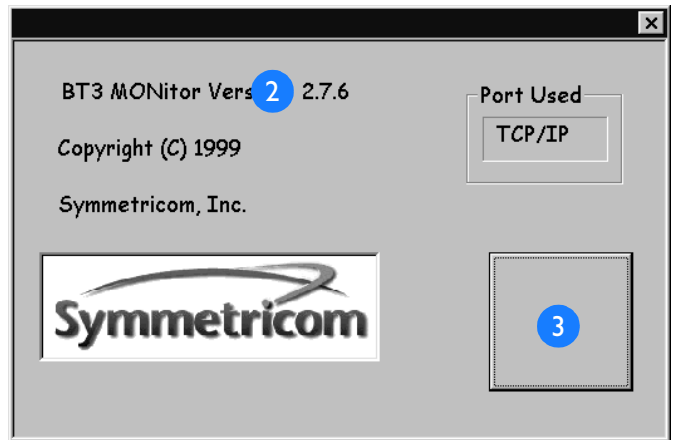
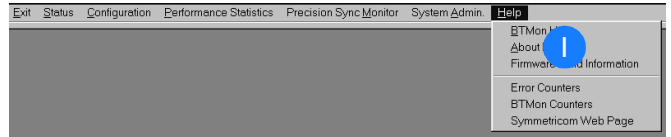

View Communication Information

1. Select Help > About BTMon.
2. View the active communication port.
3. To exit, click OK.

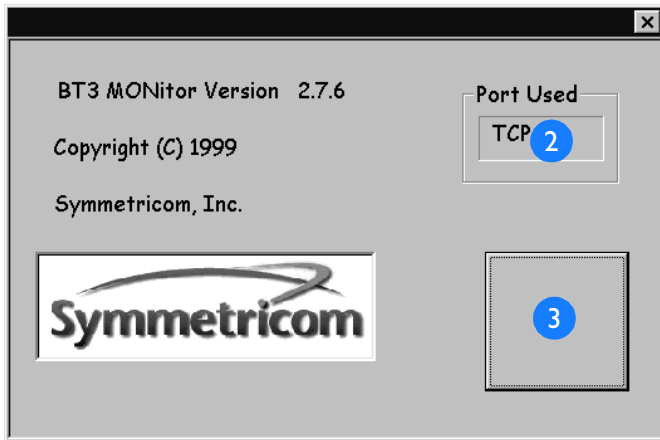

View System Firmware Information

1. Select Help > Firmware Build Information.
2. View the system firmware information.
3. To exit, click Exit.

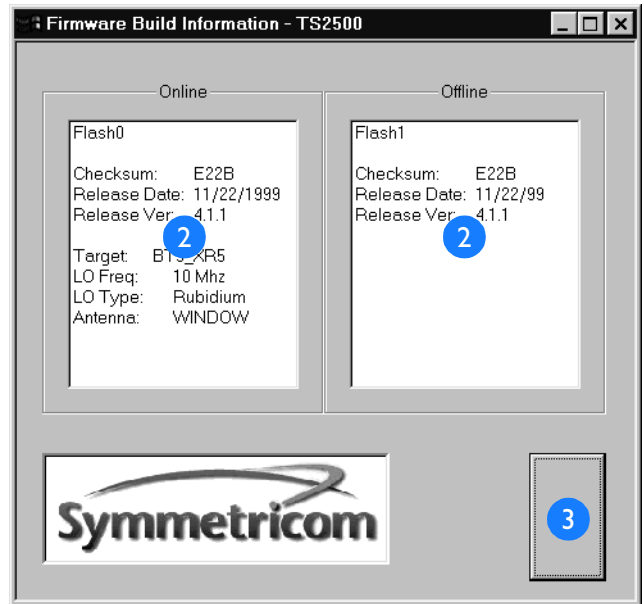

Troubleshooting

This chapter provides troubleshooting information using front-panel lamps, alarms, and events. It also describes how to return equipment, get technical and sales assistance, and obtain manual updates.

Front Panel Lamps

All front panel lamps are shown in Figure 29. The lamps are described in Table O.

Figure 29. Front Panel Indicators

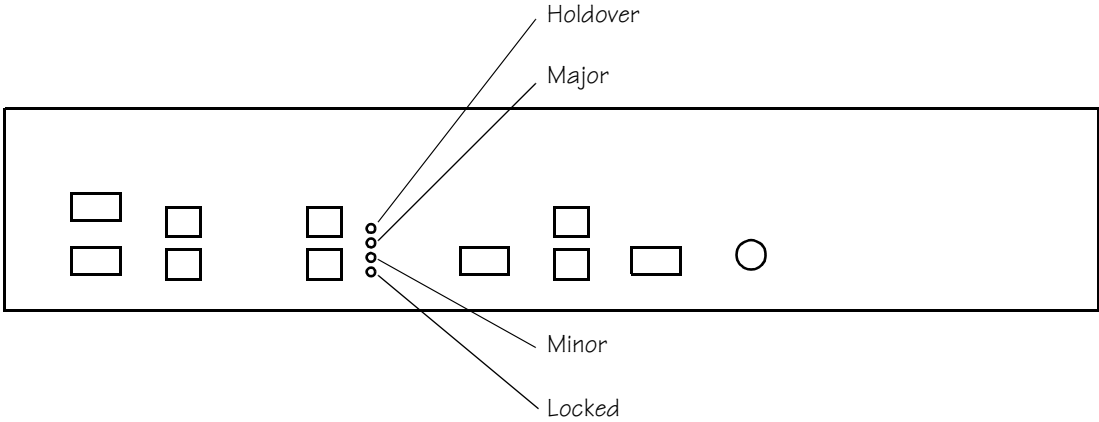

Table O. Lamp Descriptions

Lamp	Status	Description	Action
Holdover	Off	System is not in holdover	None
	Yellow	System is in holdover	Refer to the Alarm Monitor screen
Major	Off	System is not in major alarm	None
	Red	System is in major alarm	Refer to the Alarm Monitor screen
Minor	Off	System is not in minor alarm	None
	Yellow	System is in minor alarm	Refer to the Alarm Monitor screen
Locked	Off	System is not powered	Apply power, or check power source and connections
	Blinking Green	System is in warm-up	None, unless warm-up exists for more than 8 h (see note below)
	Green	System is providing Stratum I signals (if Major lamp is off)	None

Note: If the system does not exit the warm-up state, installation data may have not been entered or may have been entered incorrectly. Check that the elevation mask, GPS fix mode, location ID, and cable delay information was correctly entered on the BTMONitor Installation screen.

Theory of Alarm Processing and Troubleshooting

The following pages describe the theory behind how events and alarms are processed, and how to troubleshoot the system, based on the event and alarm messages. Refer to Figure 30 for the Alarm Monitor screen, which may be referenced during the descriptions on the following pages.

Figure 30. Alarm Monitor Screen

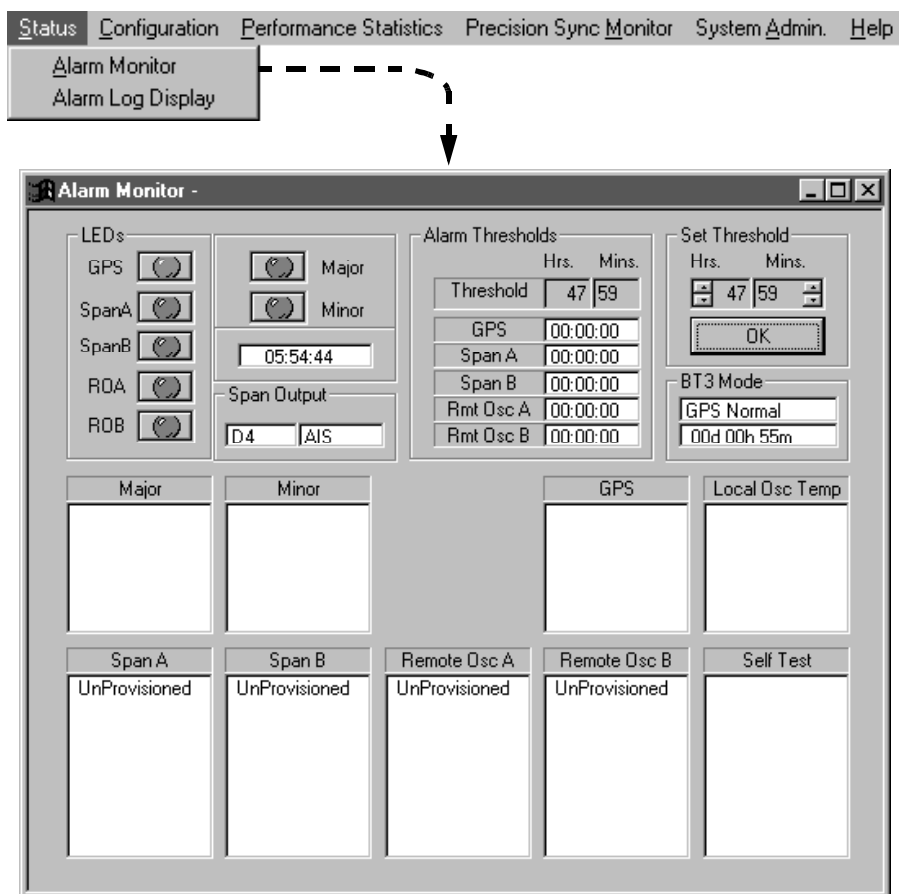

The TimeSource 2500 provides an extensive source of information about system events and alarms, which is logged and reported to the user via front panel lamps, alarm relays, TL1 messages, and the BTMONitor Alarm Monitor and Alarm Log Display screens. The Alarm Monitor screen displays all active events and alarms, for monitoring the functionality and operation of the system. The Alarm Log Display screen displays the past 512 events, and alarm history.

The TimeSource 2500 reports two types of events: transient events and events. A transient event is an intermittent or short-term non-service-affecting condition outside the normal operating conditions in an input or critical internal subsystem. An event is a standing or persistent non-service-affecting condition outside the normal operating conditions in an input or critical internal subsystem.

Each TimeSource 2500 input and critical internal subsystem may produce reportable transient events, events, and alarms. All transient events are processed through leaky buckets to correctly clear the transient event, or to escalate it to an event or alarm. Alarms are escalated through a user-adjustable threshold. For span and remote oscillator inputs, the default threshold for a standing minor alarm to escalate to a major alarm is 48 hours. For GPS inputs, the default threshold for the amount of time from the beginning of bridging mode to the initiation of a major alarm is 48 hours. Service-impacting alarm conditions are reported directly as a major alarm.

Much of the transient event and event level information reported via the BTMONitor Alarm Monitor screen is normal activity, which does not impact the performance of the timing outputs, and is useful primarily as a system operation monitoring tool. For example, the TimeSource 2500 is designed to output PRS quality signals without any view of GPS satellites for as long as 14 hours on average per day. Therefore, it is common for the system to report events regarding GPS satellite tracking and drop-out activity, even though the activity will have no impact on the performance of the outputs.

In general, minor and major alarms should appear infrequently, and troubleshooting activity is not required, unless the system is in alarm. Otherwise, it is likely the condition is transient, will clear on its own, and will have had no impact on the quality of the timing outputs.

The TimeSource 2500 reports transient events, events, and alarms for the critical subsystems and inputs listed below:

- GPS
- Span Inputs
- Remote Oscillator Inputs
- Phase Locked Loop
- Local Oscillator Temperature

Table P lists the BTMONitor Alarm Monitor screen messages, descriptions of the messages, and the pages where the descriptions can be found.

Table P. BTMONitor Alarm Monitor Screen Messages

Message	Definition	Description Page No.
GPS		
Tevt-Freq	GPS Frequency Transient Event	183
Evt-Freq	GPS Frequency Event	183
Alm-Freq	GPS Frequency Alarm	184
Tevt-Drift	GPS Drift Transient Event	184
Evt-Drift	GPS Drift Event	184
Alm-Drift	GPS Drift Alarm	185
Tevt-Timg Accur	GPS Timing Accuracy Transient Event	185
Tevt-Clk Bias	GPS Clock Bias Transient Event	185
Alm-Trk Succs	GPS Tracking Success Alarm	186
Alm-Antenna	Antenna Alarm	186
Span A or Span B		
Tevt-Freq	Span Frequency Transient Event	187
Alm-Freq	Span Frequency Alarm	188
Tevt-Drift	Span Drift Transient Event	188
Alm-Drift	Span Drift Alarm	189
Tevt-Phase	Span Phase Transient Event	189
Alm-Phase	Span Phase Alarm	190
Alm-Jitter	Span Jitter Alarm	190

Table P. BTMONitor Alarm Monitor Screen Messages (cont'd)

Message	Definition	Description Page No.
Remote Osc A or Remote Osc B		
Tevt-Freq	RO Frequency Transient Event	191
Alm-Freq	RO Frequency Alarm	192
Tevt-Drift	RO Drift Transient Event	192
Alm-Drift	RO Drift Alarm	193
Tevt-Phase	RO Phase Transient Event	193
Alm-Phase	RO Phase Alarm	194
Alm-Jitter	RO Jitter Alarm	194
Self Test		
Evt-Step	PLL Step Event	195
Alm-Step	PLL Step Alarm	196
Evt-Range	PLL Range Event	196
Alm-Range	PLL Range Alarm	197
Alm-Jitter	PLL Jitter Alarm	197
Local Osc Temp		
Evt-Step	TP Step Event	198
Alm-Step	TP Step Alarm	198
Evt-Slew	TP Slew Event	199
Alm-Slew	TP Slew Alarm	199

GPS Event and Alarm Summary

It is normal for frequent GPS transient event activity to occur, depending on the antenna location. When a transient event escalates to an event, the TimeSource 2500 enters bridging mode, and operates on its predictors, but will not report a minor or major alarm. In bridging mode, the TimeSource 2500 continues to provide Stratum 1 outputs. If the event condition persists, a minor alarm is generated. The TimeSource 2500 will not light the holdover lamp unless a minor or major GPS alarm condition exists. Table Q shows the four GPS operating modes.

Table Q. GPS Operating Modes

Mode	Description
Warm up	System has recently been reset or powered up and is establishing or re-establishing normal time and frequency output.
Normal	System is operating with valid GPS measurement data.
Bridging	System has temporarily lost GPS measurement, and is utilizing the prediction algorithm
Holdover	A GPS loss has escalated to a minor/major alarm.

The transient event, event, and alarm messages on the following pages will appear in the window labeled GPS on the Alarm Monitor screen (Figure 30).

GPS Frequency Transient Event

The GPS receiver performs a complete update of the current time (clock bias) and frequency (clock drift) estimates every second. The TimeSource 2500 compares the current frequency estimate of the corrected local oscillator with respect to GPS, and declares a GPS Frequency Event if the magnitude of the offset is greater than the 0.02 ppm threshold.

Maintenance action required: None.

GPS Frequency Event

The GPS Frequency Transient Event data is processed through a leaky-bucket alarm manager, to control escalation to an event. GPS Clock Bias Transient Events and Time Accuracy Transient Events are included in this general frequency event category. A frequency event represents an error in the GPS receiver output state or a failed oscillator. The nominal time to escalate to an event condition is 2 minutes. The maximum time to retire an event is 5 minutes.

Maintenance action required: None.

GPS Frequency Alarm

The GPS Frequency Event data is processed through a leaky-bucket alarm manager, to control escalation to an alarm.

Maintenance action required:

1. Check that the elevation mask and GPS fix mode information has been entered properly, via the BTMONitor Installation screen.
2. If an antenna alarm is also present, the cable to the antenna may have become disconnected. Reconnect the antenna cable. If the condition persists, replace the antenna cable(s).
3. If a PLL alarm is also present, replace the shelf.

GPS Drift Transient Event

The rate of change of the GPS frequency estimate is calculated to determine if the current slew rate is within the expected measurement window for GPS, given the effects of Selective Availability and dynamic changes in the number and elevation of tracked satellites.

Maintenance action required: None.

GPS Drift Event

GPS Drift Transient Event data is processed through a leaky-bucket alarm manager, to control escalation to an event. A drift event represents a small error in the GPS receiver output state outside the expected performance. Occasional drift events are normal in locations where there are antenna obstacles or sources of multipath. The nominal time to escalate to an event condition is 2 minutes. The maximum time to retire an event is 5 minutes.

Maintenance action required: None.

GPS Drift Alarm

The GPS Drift Event data is processed through a leaky-bucket alarm manager, to control escalation to an alarm.

Maintenance action required:

1. If a GPS Drift event escalates to an alarm and there are no other GPS alarms, check that the elevation mask and GPS fix mode information has been entered properly, via the BTMONitor Installation screen.
2. The TimeSource 2500 should not normally generate a GPS drift alarm because of multipath, even with a very limited view of the sky. However, it is possible to reduce the impact of low-elevation multipath by increasing the elevation mask to exclude low-elevation satellites. Check the elevation mask in the BTMONitor Installation screen. Increase the elevation mask setting, and monitor the system for 24 hours, to see if the alarm clears.

GPS Time Accuracy Transient Event

The GPS receiver estimates the current accuracy of the timing solution. The threshold for good timing solutions is 750 ns.

Maintenance action required: None.

GPS Clock Bias Transient Event

The clock bias transient event indicates the quality of the current timing solution data. The transient event is reported if there are no valid satellites to obtain a good timing solution, or if the current timing accuracy estimate exceeds the maximum threshold.

Maintenance action required: None.

GPS Tracking Success Alarm

This alarm indicates that the GPS receiver is not achieving an acceptable level of successful tracking. The system calculates a 24 hour average success rate every hour. This alarm is reported if the average daily success rate is less than 40 percent.

Maintenance action required: Check that the elevation mask, GPS fix mode, and cable delay information have been properly entered via the Installation screen.

Note: If the TimeSource 2500 suddenly stops tracking satellites, and does not reacquire any satellites for 24 hours or more, the system critical memory may have become corrupted. Reset the GPS receiver (using the Reset screen). If the condition persists, replace the shelf.

Antenna Alarm

This alarm indicates that the external antenna port is operating at an abnormal current level. This normally indicates a faulty cable or antenna pre-amp. This condition is reported directly as a minor alarm.

Maintenance action required: Check and tighten all antenna cable connections. If the alarm persists, replace the antenna. If the alarm persists, replace the antenna cable(s).

Span Input Event and Alarm Summary

The TimeSource 2500 reports and escalates transient events and events on any provisioned, but not ensembled, span line. Events on span lines not used in the BesTime output ensemble never escalate to an alarm because the span line is not being used to generate the timing outputs. Span inputs used in the BesTime output ensemble report transient events which will escalate directly to an alarm, bypassing the event level, because of the potential of the span alarm activity to impact the quality of the timing outputs.

The following transient event, event, and alarm messages will appear in the window(s) labeled Span A and/or Span B on the Alarm Monitor screen.

Span Frequency Transient Event

The input span (carrier) frequency is measured with respect to the local oscillator frequency. This measurement includes the expected frequency error of the span line, and local oscillator, over a 15 second smoothing time constant. The threshold is set to 1.1 ppm, to accommodate the expected frequency range of the oscillator over the life of the product, to allow for Stratum 2 level traceability for the incoming span line, and to accommodate permitted network wander.

Maintenance action required: None.

Span Frequency Alarm

Span Frequency Transient event data is processed through a leaky-bucket alarm manager, to control escalation to an event, or directly to a minor alarm. The nominal time to escalate is 4 seconds, and the maximum time to retire is 75 seconds. Normal SONET pointer adjustments or network rearrangement transients will not produce an alarm. A span frequency alarm condition represents a significant frequency error on the incoming span line.

Maintenance action required: Timing on the incoming span line is not within network specifications. Troubleshoot the source of the timing for the incoming span line, or contact the span line service provider.

Span Drift Transient Event

The TimeSource 2500 measures the relative difference between the input frequency of a span and the output frequency. The input frequency is smoothed, using a smoothing filter which detects and removes transients above the normal operating range of a span line. The drift event will be triggered by SONET pointer adjustments and other network rearrangement-related transient events. This permits these transients to be detected and removed before they impact the system. The TimeSource 2500 checks for drift events every 4 seconds.

Maintenance action required: None.

Span Drift Alarm

Span drift event data is processed through a leaky-bucket alarm manager, to control escalation to an event or directly to a minor alarm. Since occasional drift events are typical, the leaky bucket is set to ignore isolated pointer and network rearrangement events. The nominal time to escalate an alarm is 4 minutes, and the maximum time to retire the alarm is 2.5 minutes.

Maintenance action required: Occasional span drift alarm activity may occur as a result of network maintenance. Persistent drift alarm activity is not normal. Check the BTMONitor Alarm Log screen, and if there are multiple events per day, the span line input should be considered suspect. Timing on the incoming span line is not within specification. Troubleshoot the source of the timing for the incoming span line, or contact the span line service provider.

Span Phase Transient Event

The phase event category is used to detect “fast” phase transient events. A fast event is usually related to a timing transient in the previous network element, as opposed to a slower event played out through upstream intermediate clocks. In general, all phase events will produce drift events. A phase event is observed over a 250 ms interval after removing network jitter. The default threshold for a span phase transient event is greater than 250 ns.

Maintenance action required: None.

Span Phase Alarm

Span phase transient event data is processed through a leaky-bucket alarm manager, to control escalation to an event or alarm. The nominal time to assert is 7 seconds, and the maximum time to retire is 3 minutes.

Maintenance action required: Occasional span phase alarm activity may occur as a result of network maintenance. Persistent phase alarm activity is not normal. Check the BTMONitor Alarm Log screen, and if there are multiple events per day, the span line input should be considered suspect. This indicates that timing on the incoming span line is not within specification. Troubleshoot the source of the timing for the incoming span line, or contact the span line service provider.

Span Jitter Alarm

Jitter is measured on the incoming span line with a resolution of 50 ns. If the peak-to-peak delta phase error exceeds the GR2830 1.6 ms threshold for a period of 100 ms, an input jitter alarm is declared. This alarm is also activated if there is a loss of span line input signal for a period greater than 100 ms.

Maintenance action required: The input span line cable may have become disconnected; check and tighten all cable connections. If the alarm persists, timing on the incoming span line is not within specification. Troubleshoot the source of the timing for the incoming span line, or contact the span line service provider. If the alarm persists, replace the cable.

Remote Oscillator (RO) Input Event and Alarm Summary

The TimeSource 2500 reports and escalates transient events and events on any remote oscillator input that is provisioned, but not ensembled. Events on remote oscillator inputs not used in the BesTime output ensemble never escalate to an alarm because the remote oscillator inputs are not being used to generate the timing outputs. Remote oscillator inputs used in the BesTime output ensemble report transient events, which will escalate directly to an alarm, bypassing the event level, because of the potential of the remote oscillator input's alarm activity to impact the quality of the timing outputs.

The following transient event, event, and alarm messages will appear in the window(s) labeled Remote Osc A and/or Remote Osc B on the Alarm Monitor screen.

RO Frequency Transient Event

The input RO frequency is measured with respect to the local oscillator frequency. This measurement includes the expected frequency error of the RO as well as the local oscillator, over a smoothing constant. The threshold is set to 2.0 ppm, to accommodate the expected frequency range of the local oscillator over the life of the product and the free-running accuracy of the remote oscillator.

Maintenance action required: None.

RO Frequency Alarm

RO frequency event data is processed through a leaky-bucket alarm manager, to control escalation to an event or an alarm. The nominal time to report is 4 seconds, and the maximum time to retire is 75 seconds. An RO frequency alarm condition represents a significant issue, and should normally not occur.

Maintenance action required: The remote oscillator input is outside the normal operating frequency range. Verify the cable connections are secure. Verify the input signal is RS-422 compatible, nominally ± 1 volt differential into 100 ohms, with less than 7 volts common mode. If the signal looks good, troubleshoot the remote oscillator.

RO Drift Transient Event

The relative difference is measured between the input frequency and the current output frequency of the TimeSource 2500. The input frequency is smoothed, using an input smoothing filter. The threshold for this category is selected to detect and remove transients above the normal operating range of a remote oscillator. The threshold is 0.02 ppm. This permits these transients to be detected and removed before the system is impacted. The TimeSource 2500 checks for drift events every 15 seconds.

Maintenance action required: None.

RO Drift Alarm

RO drift transient event data is processed through a leaky-bucket alarm manager, to control escalation to an event or an alarm. Normally, drift alarms should not occur on remote oscillator inputs. The nominal time to report is 45 seconds, and the maximum time to retire is 7.5 minutes.

Maintenance action required: The remote oscillator input is experiencing abnormal jumps in frequency. Verify the cable connections are secure. Verify the input signal is RS-422 compatible, nominally ± 1 volt differential into 100 ohms, with less than 7 volts common mode. If the signal looks good, troubleshoot the remote oscillator.

RO Phase Transient Event

The phase transient event category is used to detect “fast” phase transient events. The threshold for a phase transient is greater than 250 ns.

Maintenance action required: None.

RO Phase Alarm

RO phase transient event data is processed through a leaky-bucket alarm manager, to control escalation to an event or alarm. The nominal time to assert an alarm is 7 seconds, and the maximum time to retire an alarm is 3 minutes.

Maintenance action required: The remote oscillator input is experiencing abnormal jumps in frequency. Verify the cable connections are secure. Verify the input signal is RS-422 compatible, nominally ± 1 volt differential into 100 ohms, with less than 7 volts common mode. If the signal looks good, troubleshoot the remote oscillator.

RO Jitter Alarm

The TimeSource 2500 measures jitter on the Remote Oscillator input with a resolution of 470 ps. If the peak-to-peak delta phase error exceeds the 12 ns threshold for a period of 100 ms, an input jitter alarm is declared. This alarm is also activated if there is a loss of remote oscillator input signal for a period greater than 100 ms.

Maintenance action required: The remote oscillator input cable may have become disconnected; check and tighten all cable connections. If the alarm still persists, the timing being received from the remote oscillator is not within specification. Troubleshoot the remote oscillator. If the alarm persists, replace the cable.

Phase Locked Loop (PLL) Event and Alarm Summary

The PLL events and alarms report activity associated with the 60 MHz synthesizer PLL subsystem. In general, PLL alarms indicate a potential critical hardware fault in the system. Any alarm is treated as a minor alarm immediately. If a PLL alarm occurs with simultaneous alarm activity on all provisioned inputs, a major alarm is reported.

The following transient event, event, and alarm messages will appear in the window labeled Self Test on the Alarm Monitor screen.

PLL Step Event

The step event category is used to capture abnormal phase or frequency transient “pops” in the synthesizer PLL. A step event is the magnitude of the delta between successive 250 ms samples exceeding the threshold. The threshold is 0.5 percent of the total VCXO pull-in range (70 ppm minimal).

Maintenance action required: None.

PLL Step Alarm

A step event should not occur in a normal system after the first minute from a cold power-up. The PLL step event is processed through a leaky-bucket alarm manager, to control escalation to a minor alarm. The manager is set so that a single isolated event will not escalate to an alarm. The nominal time to escalate to an alarm is 750 ms. The maximum time to retire an alarm is 40 seconds.

Maintenance action required: If the system is not in warm-up, replace the shelf.

PLL Range Event

The range event category is used to report individual 250 ms samples that exceed the normal varactor range limits. The limits are at 90 percent of the total control range.

Maintenance action required: None.

PLL Range Alarm

A range event should not occur in a normally operating system after the first minute from a cold power-up. The PLL range event is processed through a leaky-bucket alarm manager, to control escalation to a minor alarm. The leaky-bucket manager is set so that a single isolated event will not escalate to an alarm. The nominal time to escalate to an alarm is 750 ms. The maximum time to retire an alarm is 40 seconds.

Maintenance action required: If the system is in warm-up, no action is required. If a PLL range alarm occurs without simultaneous input alarm activity, the VCXO may be at the end of its pull-in range, and the shelf requires immediate replacement. If the range PLL alarm occurs with some inputs operating alarm free, there is no immediate problem, but the shelf will soon require replacement.

PLL Jitter Alarm

If the jitter level exceeds 10 counts at 10 bits for nominally 100 ms, a PLL jitter alarm is reported.

Maintenance action required: Replace the shelf.

Temperature (TP) Event and Alarm Summary

Temperature event and alarm data reports temperature changes of the local oscillator oven. Step and jitter alarms are likely indications of a hardware fault. A problem with outside air (room) temperature is indicated by a standing slew alarm, if no other alarms are present.

The following transient event, event, and alarm messages will appear in the window labeled Local Osc Temp on the Alarm Monitor screen.

TP Step Event

The step event category is used to capture abnormal step changes in the oven current of the oscillator.

Maintenance action required: None.

TP Step Alarm

A step event should not occur in a normally operating system after the first minute from a cold power-up. The oven current step event is processed through a leaky-bucket alarm manager, to control escalation to a minor alarm. The manager is set so that a single event will not escalate to an alarm. The nominal time to escalate to an alarm is 900 ms. The maximum time to retire an alarm is 20 seconds.

Maintenance action required: If the system is not in warm-up, replace the shelf.

TP Slew Event

The slew event category detects abnormal slew rate changes in the oven current. A large slew in oven current is normal only during a power-up condition.

Maintenance action required: None.

TP Slew Alarm

Persistent oven current slew usually indicates an abnormal temperature environment. The TP Slew event is processed through a leaky-bucket alarm manager, to control escalation to a minor alarm. The manager is set so that a single event will not escalate to an alarm. The nominal time to escalate to an alarm is 7 minutes. The maximum time to retire an alarm is 10 minutes.

Maintenance action required:

1. Determine if the TimeSource 2500 Shelf is being exposed to an unusual amount of air flow variation (for example, the shelf is located next to a heating vent). If so, reposition the shelf.
2. Check the room temperature, repair the heating/air conditioning system. If the room temperature is within the specified operating range for the unit (0 degrees Celsius to 50 degrees Celsius), and the alarm persists, replace the shelf.

TLI Messages

The TimeSource 2500 sends out two types of TLI messages via the Craft communication port: alarms and events. The format of each of these are described below.

Formats

Alarms

Alarms are sent out as Report Alarm messages in the following format:

```
<cr> <lf> <lf>
<sid> <date> <time>
<almcode> <atag> REPT ALM <modifier>
"<aid>:<ntfcncde>,<condtype>,<srveff>,<ocrdat>,
<ocrtm>,,,:\"<conddescr>\"
<;>
```

Events

Events are sent out as Report Event messages in the following format:

```
<cr> <lf> <lf>
<sid> <date> <time>
<atag> REPT EVT <modifier>
"<aid>:<condtype>,<condeff>,<ocrdat>,
<ocrtm>,,,:\"<conddescr>\"
<;>
```

Parameters

The parameters used in the alarm and event messages are defined in Table R.

Table R. Parameter Definitions

Parameter	Definitions
aid	This parameter is the access identifier which is the equipment reporting the condition.
almcode	This parameter is the alarm code which identifies the severity of the alarm. If multiple alarms are reported, the value for almcode is the highest severity of those reported. Valid values are: ** = major alarm * = minor alarm A = event
atag	This parameter is the automatic message tag which is a decimal number with a maximum of three characters (001 through 999, after which numbering restarts at 001). It is assigned by the system to sequence and correlate automatic messages.
conddescr	This parameter is the condition description which is a text description of the condition reported by the system, enclosed within /* and */. The system returns one conddescr per message. Valid values are listed in Table S.
condeff	This parameter indicates the effect of the condition on the equipment. A transient condition does not change the basic state of the equipment. Valid values are: SC = standing condition raised CL = standing condition cleared TC = transient condition

Table R. Parameter Definitions (cont'd)

Parameter	Definitions
condtype	<p>This parameter is the condition type. It indicates the type of condition being reported. Valid values are:</p> <p>MODE = the equipment is powering up or software downloading</p> <p>ERROR = there is an error in one of the signals being ensembled</p> <p>LOS = there is a loss of one of the signals being ensembled</p> <p>AIS = there is an alarm indication signal being received on one of the external span inputs</p> <p>STATE = there is a problem with the GPS signal</p>
date	This parameter is the current date in the 8 digit form yyyy-mm-dd, where yyyy is year, mm is month (01–12), and dd is day (01–31).
modifier	Same as aid.
ntfcncde	<p>This parameter is the notification code which indicates the severity of the condition. Valid values are:</p> <p>CL = cleared</p> <p>MJ = major alarm</p> <p>MN = minor alarm</p> <p>NA = not alarmed</p> <p>NR = not reported</p>
ocrdat	This parameter is the date an event occurred.
ocrtm	This parameter is the time an event occurred.
sid	This parameter is the source identifier (site ID). It identifies the system sending the message and is the equipment’s CLLI code. The sid is the same as the location on the Installation screen.

Table R. Parameter Definitions (cont'd)

Parameter	Definitions
srveff	This parameter identifies how the condition affects service. Valid values are: SA = service affecting NSA = not service affecting
time	This parameter is the current time in the 6 digit form hh-mm-ss where hh is hours (0–23), mm is minutes (0–59), and ss is seconds (0–59). The factory setting is GMT for local time.

Message Troubleshooting

To troubleshoot alarm and event messages, refer to Table S. Table S lists the messages, what the messages mean, and what action to take to troubleshoot the problem.

Table S. Message Troubleshooting

Message (conddescr)	Meaning	Recommended Action
ALARMS		
HARDWARE FAILURE	A failure has been detected on the system hardware.	Replace the system.
HOLDOVER	All inputs (GPS signals, span inputs, and remote oscillator inputs) are lost or unacceptable, and the system is now using the internal oscillator.	Troubleshoot the GPS, SPAN x, and RO x error messages (check the cable, source, etc.).
GPS ERROR	The GPS receiver is reporting an error.	<ol style="list-style-type: none"> 1. Check the view of the sky for obstructions. 2. Raise the antenna elevation mask setting, using the BTMONitor Installation screen. 3. Check the cable connections between the TimeSource 2500 Shelf and the antenna. 4. If the error repeats, replace the antenna. 5. If the error repeats, replace the lightning suppressor. 6. If the error repeats, replace the cable.
RO x ERROR	An error has been detected on the specified remote oscillator input signal.	Troubleshoot the specified remote oscillator input (check signal frequency). Verify the input frequency matches the equipment configuration.
RO x LOSS OF SIGNAL	The specified remote oscillator input signal has been lost.	Troubleshoot the specified remote oscillator input (check the cable, connections, source).
SPAN x AIS	An alarm indication signal (AIS) has been received on the specified T I input span.	Troubleshoot the specified T I input span signal (check the source).
SPAN x ERROR	An error has been detected on the specified T I input span.	Troubleshoot the specified T I input span signal (include checks for signal frequency and jitter).

Table S. Message Troubleshooting (cont'd)

Message (conddescr)	Meaning	Recommended Action
SPAN x LOSS OF SIGNAL	The signal on the specified span input has been lost.	Troubleshoot the specified TI input span signal (check the cable, connections, source).
TEMPERATURE ERROR	A temperature error has been detected on the internal oscillator.	If this occurs momentarily during power-up, none required. If this does not occur during power-up: 1. Check that the ambient air temperature is within the TimeSource 2500 environmental specifications. If not, correct the ambient temperature with heating or air conditioning. 2. If the ambient air temperature is within the TimeSource 2500 environmental specifications, replace the system.
EVENTS		
DOWNLOAD FAILED	The software download has failed.	Retry the software download.
DOWNLOAD IN PROGRESS	Software is being downloaded.	Wait until the download has been completed.
DOWNLOAD SUCCESSFUL	The software has been downloaded successfully.	None required.
GPS ERROR	The GPS receiver is reporting an error.	None required.
POWER UP RESTART	The system processor has just started up.	None required.
RO x ERROR	An error has been detected on the specified remote oscillator input signal.	Wait until this becomes a minor alarm, or start troubleshooting the specified remote oscillator input now (check the signal frequency).

Table S. Message Troubleshooting (cont'd)

Message (conddescr)	Meaning	Recommended Action
RO x LOSS OF SIGNAL	The specified remote oscillator input signal has been lost.	Wait until this becomes a minor alarm, or start troubleshooting the specified remote oscillator input now (check the cable, connections, source).
SPAN x AIS	An alarm indication signal (AIS) has been received on the specified T I input span.	Wait until this becomes a minor alarm, or start troubleshooting the specified span input now (check the source).
SPAN x ERROR	An error has been detected on the specified T I input span.	Wait until this becomes a minor alarm, or start troubleshooting the specified span input now (include checks for signal frequency and jitter).
SPAN x LOSS OF SIGNAL	The signal on the specified span input has been lost.	Wait until this becomes a minor alarm, or start troubleshooting the specified span input now (check the cable, connections, source).
BRIDGING	All inputs (GPS signals, span inputs, and remote oscillator inputs) are lost or unacceptable, and the system is using the internal oscillator.	None required.
TEMPERATURE ERROR	A temperature error has been detected on the internal oscillator.	If this occurs momentarily during power-up, none required. If this does not occur during power-up: check that the ambient air temperature is within the TimeSource 2500 environmental specifications. If not, correct the ambient temperature with heating or air conditioning.

Repair and Return

When returning defective equipment for factory repair, obtain the following information prior to calling Symmetricom:

- A complete description of the trouble (alarms, equipment behavior, etc.), part number, serial number, issue/revision level, and warranty expiration date.
- If the warranty has expired, a purchase order with “bill to” information.
- A customer field technical contact including address, phone number and FAX number.
- Return shipping information.

To return defective or damaged equipment, follow Procedure G.

Procedure G. Equipment Return

Step	Action
1	<p>Call your local Symmetricom distributor or Symmetricom's Inside Sales (refer to the Sales subsection), and obtain a Return Material Authorization (RMA) number and shipping address.</p> <p><i>Note:</i> Retain the RMA number for future reference. The RMA number is used by Symmetricom for internal tracking of the unit. Reference the RMA number in all communications with Symmetricom regarding the unit.</p>
2	<p>Pack the defective equipment, including a list containing all the information obtained above, in the original packing material. If the original packing material is not available, inform Symmetricom, and the appropriate shipping material will be provided.</p> <p><i>Note:</i> Equipment must be returned in the original packaging, or approved replacement packaging, for the warranty to be honored.</p>
3	<p>Mark the RMA number and the equipment serial number on the outside of the shipping carton.</p>
4	<p>Ship the equipment prepaid and insured to one of the addresses below, as directed by the Customer Assistance Center:</p> <p>Symmetricom Attn: Customer Service 2300 Orchard Parkway San Jose, CA 95131</p> <p>or</p> <p>Symmetricom Attn: Repair and Return Building 7 Aguada West Industrial Site Aguada, Puerto Rico 00602</p> <p><i>Note:</i> Repaired equipment is typically shipped within 30 days of receipt by Symmetricom, or per contract terms. Shipping costs to Symmetricom are paid by the customer; shipping costs back to the customer are paid by Symmetricom.</p>

Technical Assistance

For technical assistance, contact the following:

Symmetricom, Inc.
2300 Orchard Parkway
San Jose, CA 95131-1017

U.S.A. Call Center:
888-367-7966 (from inside U.S.A. only – toll-free)
408-428-7907

U.K. Call Center:
+44.7000.111666
+44.1604.586740

Fax: 408-428-7998

E-mail: ctac@symmetricom.com

Internet: <http://www.symmetricom.com>

Sales

For sales assistance, contact the following:

Symmetricom, Inc.
2300 Orchard Parkway
San Jose, CA 95131-1017

U.S.A. Call Center:
888-367-7966 (from inside U.S.A. only – toll-free)
408-428-7907

U.K. Call Center:
+44.7000.111888
+44.1604.586740

Fax: 408-428-7998

E-mail: info@symmetricom.com

Internet: <http://www.symmetricom.com>

Manual Updates

From time to time, this manual may be updated. The updated version of the manual will be available for downloading in electronic form via the internet. After downloading, the manual can be viewed on a computer, or printed.

To register for access to the manual update site via the internet, send an e-mail with the following information to “manuals@symmetricom.com”:

- Name
- Title
- Company
- Address

An e-mail will be returned, which will include the internet address of the update site, and a name and password necessary to access the site.

.....

Specifications

This chapter provides equipment specifications.

Standard Antenna

Type:	Active volute antenna, right-hand circular polarized
Voltage (via signal cable):	12 V dc nominal
Current (via signal cable):	12 mA to 42 mA
Gain:	23 dB
Connector:	TNC female
Dimensions: (excluding mount)	
Height:	11 in.
Diameter:	4 in.
Weight:	9 oz
Operating Temperature:	-25 °C to +85 °C
Storage Temperature:	-40 °C to + 85 °C
Operating Humidity:	0% to 100% relative humidity

40 dB High-Gain Antenna

Type:	Right-hand circular polarized
Voltage (via signal cable):	12 V dc nominal
Current (via signal cable):	46 mA to 55 mA
Gain:	40 dB
Connector:	N female
Dimensions: (excluding mount)	
Height:	4.34 in.
Diameter:	3.10 in.
Weight:	6 oz
Operating Temperature:	-25 °C to +85 °C
Storage Temperature:	-40 °C to + 85 °C
Operating Humidity:	0% to 100% relative humidity

50 dB High-Gain Antenna

Type:	Right-hand circular polarized
Voltage (via signal cable):	12 V dc nominal
Current (via signal cable):	37 mA to 45 mA
Gain:	50 dB
Connector:	N female
Dimensions: (excluding mount)	
Height:	4.34 in.
Diameter:	3.10 in.
Weight:	6 oz
Operating Temperature:	-25 °C to +85 °C
Storage Temperature:	-40 °C to + 85 °C
Operating Humidity:	0% to 100% relative humidity

Remote Communication Port

Connector Type:	9-pin, female DB9 connector
Connector Label:	Remote RS-232
Connector Location:	Front panel
Electrical Interface:	RS-232
Configuration:	Data terminal equipment (DTE)
Baud Rate:	9600 bps

Craft Communication Port

Connector Type:	RJ-45
Connector Label:	Craft
Connector Location:	Front panel
Electrical Interface:	RS-232
Baud Rate:	9600 bps

TI Inputs

Connector Type:	RJ-45
Connector Label:	Input (Span A and Span B)
Connector Location:	Front panel
Frequency:	1.544 MHz
Impedance:	100 Ω \pm 5 Ω
Format:	DS1
Line Code:	Alternate mark inversion (AMI)
Signal Level:	1.5 V to 4.5 V, base to peak (terminated) 0.15 V to 0.45 V, base to peak (bridged)
Framing:	D4 ESF
Jitter Tolerance:	Meets GR-1244 requirements

Remote Oscillator Inputs

Connector Type:	RJ-45
Connector Label:	Input (Span A and Span B)
Connector Location:	Front panel
Impedance:	120 Ω
Frequency:	5 MHz
Format:	RS-422
Voltage:	Nominally ± 1 V differential into 100 Ω

TI Outputs

Connector Type:	RJ-45
Connector Label:	Output (Span A and Span B)
Connector Location:	Front panel
Frequency:	1.544 MHz
Impedance:	100 Ω
Format:	DS1
Payload:	All ones
Line Code:	Alternate mark inversion (AMI)
Pulse Amplitude:	2.4 V to 3.6 V terminated into 100 Ω base to peak
Framing:	D4 ESF
Transmission During Alarm:	SSM (ESF only) AIS Squelch Forced

Time of Day Output

Connector Type:	9-pin, female DB9 connector
Connector Label:	TOD RS-422
Connector Location:	Front panel
Time of Day Data Format:	
Network Time Protocol (NTP), Type 4, Format 2 Driver:	
Time Format:	Year Julian-date hour:minute:second:millisecond
Alarm Fields:	First character, space = machine synchronized, First character, ? = machine out of synchronization
Cisco Systems:	
Time Format:	Year/month/day, hour:minute:second
Alarm Fields:	Alarm severity, source, and cause where the TOD alarm codes are defined as follows: Alarm severity: EV: event MN: minor alarm MJ: major alarm CL: critical alarm Alarm cause: Holdover BT3 Warm-up Hardware fault
Electrical Interface:	RS-485
Baud Rate:	9600 bps
1 pps:	
Level:	RS-485 Compliant
On-Time Edge:	Rising
Pulse Width:	100 μ s nominal
UTC Accuracy:	\pm 500 ns, positive pulse
Jitter:	Less than 1 ns peak-to-peak

10 MHz Output

Connector Type:	BNC
Connector Label:	10 MHz Output
Connector Location:	Front panel
Frequency:	10 MHz
Impedance:	50 Ω
Format:	Sine wave
Amplitude:	13 dBm \pm 2 dBm
Harmonic Spurious:	Less than -60 dBc
Phase Noise: (referenced at 10 MHz)	-120 dBc @ 100 Hz -135 dBc @ 1 kHz -135 dBc @ 10 kHz -135 dBc @ 100 kHz -135 dBc @ 1 MHz

Alarms

Connector Type:	RJ-45
Connector Label:	Alarms
Connector Location:	Front panel
Contact Type:	Dry
Contact Rating:	1 A @ 30 V dc 0.5 A @ 60 V dc 0.5 A @ 125 V ac
Severity Levels:	Major Minor
Major:	Closed when not powered, closed when powered and in Major alarm, open when powered and not in Major alarm
Minor:	Open when not powered, open when powered and not in Minor alarm, closed when powered and in Minor alarm

Indicators

Labels:	Holdover Major Minor Locked
Type:	Light emitting diode

Power

Connectors:	Male DB9 (both)
Connector Labels:	Power A Power B
Voltage:	–36 V dc to –60 V dc (each connector)
Current:	1.8 A cold start at –36 V 600 mA standard operation
Start Up Power:	Less than 70 W
Steady State Power: (25 °C)	27 W
Fuse for Battery Feed: (Recommended)	3 A

Shelf Mechanical

Mounting:	Wall 19 in. rack 23 in. rack
Rack Mounting Position:	Flush 5 in. offset
Width:	15.1 in.
Height:	2.8 in.
Depth:	9 in.
Weight:	7.5 lb

Wire-Wrap Panel Mechanical

Mounting:	19 in. rack 23 in. rack
Rack Mounting Position:	Flush 5 in. offset
Width:	17.1 in.
Height:	3.5 in.
Depth:	6.75 in.
Weight:	1 lb

Shelf and Wire-Wrap Panel Environmental

Operating Temperature:	0 °C to + 50 °C
Operating Humidity:	5 % to 85 % RH
Electromagnetic Compliance:	FCC Part 15, Sub Part B, Class A